

NOW PART OF
**ASTRA TECH
IMPLANT SYSTEM**
DENTSPLY SIRONA



Astra Tech Implant System®

Product catalog 2020

Astra Tech Implant System® EV



Endless possibilities for superior outcomes

Astra Tech Implant System EV has the flexibility and versatility to enable lifelong function and natural esthetics. The system is clinically proven, supported by science and the survival rate is outstanding.

The design philosophy of the Astra Tech Implant System EV is based on the natural dentition. This site-specific, prosthetic driven approach is supported by a flexible surgical protocol and a simple prosthetic workflow, providing increased confidence and satisfaction for all members of the treatment team.

- Versatile implant designs, including straight, conical, sloped, short, narrow and wide, using only one surgical tray
- Flexible drilling protocol allows for preferred primary stability
- Restorative components including round and triangular options supporting soft tissue sculpturing
- Unique interface with one-position-only placement for:
 - Atlantis patient-specific abutments
 - Self-guiding impression components that require only one hand for precise seating

The foundation for Astra Tech Implant System EV is the unique Astra Tech Implant System BioManagement Complex, well-documented for its outstanding long-term marginal bone maintenance and esthetic results.



Astra Tech Implant System®

CONTENTS

Overview

Product overview 3.0	4
Product overview 3.6	6
Product overview 4.2	8
Product overview 4.8	10
Product overview 5.4	12

Surgery

Implants – Astra Tech Implant EV	16
Cover screws	17
Healing abutments	
– HealDesign™ EV/Healing Uni EV	18

Prosthetics

Temporization – implant level

TempDesign™ EV/TempAbutment EV	21
Abutment screws	21

Cement-retained restorations – implant level

TiDesign™ EV	22
ZirDesign™ EV	23
CastDesign™ EV	23
TitaniumBase EV	24
Impression and laboratory components	
– implant level	25

Cement-retained restorations – abutment level

Direct Abutment™ EV	27
---------------------	----

Screw-retained restorations – abutment level

Uni Abutment EV	29
Angled Abutment EV	31
Multibase EV – SmartFix® concept	32

Attachment retained restorations – abutment level

Locator™ EV	36
Ball Abutment EV	37

Instruments

Trays	40
Washtray EV	43
Drills	44
Surgical instruments	48
Surgical units	50
Restorative instruments	52
Laboratory products	55

Astra Tech Implant EV Profile

Product overview P4.2	58
Product overview P4.8	60
Implants – Astra Tech Implant EV Profile	62
Surgical Instruments	63
Healing abutments	64
Temporary abutments	65
Cement-retained restorations	
– TiDesign™ Profile EV	66
Screw-retained restorations	66
Impression and laboratory components	67

Guided Surgery

Trays for guided surgery	69
Punch/Initial Drill	71
Drills	72
Implant Driver EV-GS	75
PositioningAid	75
Fixation system	76
Sleeves	76

Repair and retrieval

Compatibility table	78
Remove/retrieve screw fragments	79
Clean internal threads	80
Remove/retrieve Uni Abutments EV/implants	81
General instruments	82

Appendix

Material matrix	83
The numbers within brackets (X) refer to material matrix on page 83.	
Torque guide	84
Explanation of the symbols on labels and instructions for use	84
Index: order by reference number	85
Index: alphabetical order	91

For more information also follow the manufacturer's instructions:

Zest Anchors

- Instructions for use – Locator® implant attachment system
- Locator® Implant Attachment System, Technique Manual for detailed handling of the Locator™ Abutment

Cendres Métaux

- Attachment for prosthetic dentistry for detailed handling of the Dalbo®-Plus Female part

All products are subject to change without notice. All products may not be regulatory cleared/released/licensed in all markets. Please contact your local Dentsply Sirona Implants representative for current product assortment and availability.

To improve readability for our customers, Dentsply Sirona does not use ® or ™ in body copy. However, Dentsply Sirona does not waive any right to the trademark and nothing herein shall be interpreted to the contrary.

All trademarks and company names are the property of their respective owners.

Product illustrations are not to scale.

Product overview

3.0

GREEN

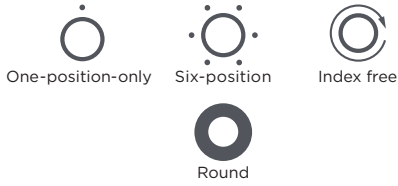

Implants

Astra Tech Implant EV 3.0 S



- 8 mm 26301
- 9 mm 26302
- 11 mm 26303
- 13 mm 26304
- 15 mm 26305

Cover screw



- 0 mm 25280

Healing abutments

HealDesign™ EV 3.0



- Ø 3.5 2.5 mm 25901
- Ø 3.5 3.5 mm 25298
- Ø 3.5 4.5 mm 25297
- Ø 3.5 6.5 mm 25795

Healing Uni EV 3.0



- Ø 4 2 mm 25574
- Ø 4 3 mm 25575
- Ø 4 4 mm 25576
- Ø 4 6 mm 25577

Cement-retained

Temporary abutments

TempDesign™ EV



- Ø 6.5 mm 25503

Temp Abutment EV

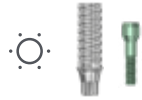

- Ø 3.3 1 mm 26251

Abutments

TiDesign™ EV 3.0



- Ø 4.0 2.5 mm 25330
- Ø 4.0 1.5 mm 25331
- Ø 4.0 15° 1.5 mm 25332

Screw-retained

Abutments

Uni Abutment EV 3.0



- 2 mm 25555
- 3 mm 25556
- 5 mm 25557

Healing caps

Uni Abutment EV
Heal Cap



- Ø 4.3 Short 25952
- Ø 4.3 25616
- Ø 5.5 Short 25953
- Ø 5.5 25617









Abutment









Uni Abutment EV
Pick-up



- Ø 4.3 Short 26245
- Ø 4.3 26247
- Ø 5.5 Short 26246
- Ø 5.5 26248

Note: Atlantis patient-specific prosthetic solutions are available.
Speak with your local Dentsply Sirona Implants representative for more information.

<p>Direct Abutment™ EV 3.0</p>  <p>Ø 3.3 1 mm 25361 Ø 3.3 2 mm 25362 Ø 3.3 3 mm 25363</p> <p>TitaniumBase EV 3.0</p>  <p>Ø 4.0 1 mm 25924 Ø 4.0 2 mm 25925</p>	<p align="center">Implant impressions</p> <p>Implant Pick-Up EV</p>  <p>Long 26231</p> <p>Implant Transfer EV</p>  <p>Long 25534</p> <p>Implant Pick-Up Design EV</p>  <p>26239</p>	<p align="center">Lab products</p> <p>Lab Abutment Screw EV</p>  <p>25476 QTY 3</p> <p>Lab Pin Design EV</p>  <p>25528</p> <p>Implant Replica EV</p>  <p>25543</p>
---	--	---

<p align="center">impressions</p> <p>Uni Abutment EV Transfer</p>  <p>26249</p>	<p align="center">Lab products</p> <p>Uni Abutment EV Replica</p>  <p>25615</p> <p>Lab Abutment Pin EV</p>  <p>Short 25643 Intermediate 25644 Long 25645</p> <p>Lab Bridge Screw EV</p>  <p>25656 QTY 3</p>	<p align="center">Bridge screw</p> <p>Bridge Screw EV</p>  <p>25481</p>	<p align="center">Cylinders</p> <p>Uni Abutment EV Temporary Cylinder</p>  <p>26250</p> <p>Uni Abutment EV Semi-Burnout Cylinder</p>  <p>25647</p> <p>Uni Abutment EV Burnout Cylinder</p>  <p>25649</p>
---	--	---	---

Product overview

3.6

PURPLE



Implants

Astra Tech Implant EV 3.6 S



- 6 mm 26310
- 8 mm 26311
- 9 mm 26312
- 11 mm 26313
- 13 mm 26314
- 15 mm 26315
- 17 mm 26316

Cover screw



0 mm 25281

Healing abutments

HealDesign™ EV 3.6



- Ø 4 2.5 mm 25902
- Ø 4 3.5 mm 25300
- Ø 4 4.5 mm 25299
- Ø 4 6.5 mm 25796
- Ø 5 2.5 mm 25903
- Ø 5 3.5 mm 25920
- Ø 5 4.5 mm 25904
- Ø 5 6.5 mm 25905
- Ø 6 3.5 mm 25906
- Ø 6 4.5 mm 25907
- △ Ø 5 3.5 mm 25301

Healing Uni EV 3.6



- Ø 4 2 mm 25285
- Ø 4 3 mm 25578
- Ø 4 4 mm 25286
- Ø 4 6 mm 25287

Cement-retained

Temporary abutments

TempDesign™ EV



Ø 7 5 mm 25504

Temp Abutment EV



Ø 4.0 1 mm 26252

Abutments

TiDesign™ EV 3.6



- Ø 4.5 2.5 mm 25334
- Ø 4.5 20° 1.5 mm 25335
- △ Ø 5.5 1.5 mm 25333

CastDesign™ EV 3.6



Ø 4.1 1 mm 25326

ZirDesign™ EV 3.6



- Ø 4.5 2.5 mm 25316
- Ø 4.5 20° 1.5 mm 25317
- △ Ø 5.5 1.5 mm 25315

Screw-retained

Abutments

Uni Abutment EV 3.6



- 1 mm 25558
- 2 mm 25559
- 3 mm 25560
- 5 mm 25561

Angled Abutment EV 3.6 20°



- Ø 4.2 1 mm 25619
- Ø 4.2 2 mm 25620
- Ø 4.2 1 mm 25621
- Ø 4.2 2 mm 25622

Multibase Abutment EV 3.6



- 1.5 mm 26159
- 2.5 mm 26160
- 3.5 mm 26161
- 17° 1.5 mm 26162
- 17° 2.5 mm 26163
- 17° 1.5 mm 26166
- 17° 2.5 mm 26167
- 30° 1.5 mm 26164
- 30° 2.5 mm 26165
- 30° 1.5 mm 26168
- 30° 2.5 mm 26169

Healing caps

Uni Abutment EV Heal Cap



- Ø 4.3 Short 25952
- Ø 4.3 25616
- Ø 5.5 Short 25953
- Ø 5.5 25617

Angled Abutment EV Heal Cap



25650

Multibase EV Heal Cap



Ø 5.4 - 4 mm 26193

Abutment

Uni Abutment EV Pick-up



- Ø 4.3 Short 26245
- Ø 4.3 26247
- Ø 5.5 Short 26246
- Ø 5.5 26248

Uni Abutment EV Transfer



26249

Angled Abutment EV Pick-up



26244

Attachment-retained

Abutments

Locator™ Abutment EV 3.6



- 1 mm 25657
- 2 mm 25658
- 3 mm 25659
- 4 mm 25660
- 5 mm 25661

Ball Abutment EV 3.6











- 1 mm 25684
- 2 mm 25685
- 3 mm 25686
- 4 mm 25687
- 5 mm 25688
- 7 mm 25689



















Abutment impressions







Locator™ Abutment Pick-up



24484

<p>Direct Abutment™ EV 3.6</p>  <p>Ø 4 1 mm 25364 Ø 4 2 mm 25365 Ø 4 3 mm 25366</p> <p>TitaniumBase EV 3.6</p>  <p>Ø 4.1 1 mm 25926 Ø 4.1 2 mm 25927</p>	<p>Implant impressions</p> <p>Implant Pick-Up EV</p>  <p>Short 26227 Long 26232</p> <p>Implant Transfer EV</p>  <p>Short 25535 Long 25536</p> <p>Implant Pick-Up Design EV</p>  <p>Short 26235 Long 26240</p>	<p>Lab products</p> <p>Lab Abutment Screw EV</p>  <p>25477 QTY 3</p> <p>Lab Pin Design EV</p>  <p>25528</p> <p>Implant Replica EV</p>  <p>25544</p>
--	--	--

<p>impressions</p> <p>Multibase EV Pick-up</p>  <p>26195</p> <p>Multibase EV Transfer</p>  <p>26194</p>	<p>Lab products</p> <p>Uni Abutment EV Replica</p>  <p>25615</p> <p>Angled Abutment EV Replica</p>  <p>25652</p> <p>Multibase EV Replica</p>  <p>26201</p> <p>Lab Abutment Pin EV</p>  <p>Short 25643 Intermediate 25644 Long 25645</p> <p>Lab Bridge Screw EV</p>  <p>25656 QTY 3</p> <p>Multibase EV Lab Pin</p>  <p>14 mm 26197 18 mm 26198 22 mm 26199</p>	<p>Cylinders</p> <p>Uni Abutment EV Temporary Cylinder</p>  <p>26250</p> <p>Uni Abutment EV Semi-Burnout Cylinder</p>  <p>25647</p> <p>Uni Abutment EV Burnout Cylinder</p>  <p>25649</p> <p>Angled Abutment EV Temporary Cylinder</p>  <p>25654</p> <p>Angled Abutment EV Semi-Burnout Cylinder</p>  <p>25653</p> <p>Angled Abutment EV Burnout Cylinder</p>  <p>25655</p> <p>Multibase EV Temporary Cylinder</p>  <p>26202</p> <p>Multibase EV Burnout Cylinder</p>  <p>26203</p> <p>Bridge screws</p> <p>Bridge Screw EV</p>  <p>25481</p> <p>Multibase EV Bridge Screw</p>  <p>26196</p>
---	---	---

<p>Replicas</p> <p>Locator™ Abutment Replica</p>  <p>24485</p> <p>Ball Abutment EV Replica</p>  <p>25826</p>	<p>Attachment components</p> <p>Dalbo Plus Female Part TE Basic, complete</p>  <p>25834</p> <p>Locator™ Process Kit</p>  <p>24483</p> <p>Locator™ Insert - Male</p>  <p>Blue 24488 Pink 24487 Clear 24486</p> <p>Locator™ Insert - Extended Range Male</p>  <p>Grey 25679 Red 24492 Orange 25843 Green 24489</p> <p>OD Cylinder EV</p>  <p>25638</p>
---	---

Product overview

4.2

YELLOW



Implants

Astra Tech Implant EV 4.2 S



- 6 mm 26320
- 8 mm 26321
- 9 mm 26322
- 11 mm 26323
- 13 mm 26324
- 15 mm 26325
- 17 mm 26326

Astra Tech Implant EV 4.2 C



- 8 mm 26331
- 9 mm 26332
- 11 mm 26333
- 13 mm 26334
- 15 mm 26335
- 17 mm 26336

Cover screw



0 mm 25282

Healing abutments

HealDesign™ EV 4.2



- Ø 5.0 2.5 mm 25908
- Ø 5.0 3.5 mm 25501
- Ø 5.0 4.5 mm 25302
- Ø 5.0 6.5 mm 25797
- Ø 6.5 2.5 mm 25909
- Ø 6.5 3.5 mm 25910
- Ø 6.5 4.5 mm 25911
- Ø 6.5 6.5 mm 25912
- Δ Ø 5 3.5 mm 25303
- Δ Ø 6.5 3.5 mm 25304

Healing Uni EV 4.2



- Ø 4 2 mm 25288
- Ø 4 3 mm 25579
- Ø 4 4 mm 25289
- Ø 4 6 mm 25290

Cement-retained

Temporary abutments

TempDesign™ EV



Ø 9 5 mm 25505

Temp Abutment EV



Ø 4.5 1 mm 26253

Abutments

TiDesign™ EV 4.2



- Ø 5.5 2.5 mm 25338
- Ø 5.5 20° 1.5 mm 25339
- △ Ø 5.5 1.5 mm 25336
- △ Ø 7.0 1.5 mm 25337

CastDesign™ EV 4.2



Ø 4.1 1 mm 25327

ZirDesign™ EV 4.2



- Ø 5.5 2.5 mm 25320
- Ø 5.5 20° 1.5 mm 25321
- △ Ø 5.5 1.5 mm 25318
- △ Ø 7.0 1.5 mm 25319

Screw-retained

Abutments

Uni Abutment EV 4.2



- 1 mm 25562
- 2 mm 25563
- 3 mm 25564
- 5 mm 25565

Angled Abutment EV 4.2 20°



- Ø 4.2 1 mm 25625
- Ø 4.2 2 mm 25626
- Ø 4.2 1 mm 25627
- Ø 4.2 2 mm 25628

Multibase Abutment EV 4.2



- 1.5 mm 26170
- 2.5 mm 26171
- 3.5 mm 26172
- 17° 1.5 mm 26173
- 17° 2.5 mm 26174
- 17° 1.5 mm 26177
- 17° 2.5 mm 26178
- 30° 1.5 mm 26175
- 30° 2.5 mm 26176
- 30° 1.5 mm 26179
- 30° 2.5 mm 26180

Healing caps

Uni Abutment EV Heal Cap



- Ø 4.3 Short 25952
- Ø 4.3 25616
- Ø 5.5 Short 25953
- Ø 5.5 25617

Angled Abutment EV Heal Cap



25650

Multibase EV Heal Cap



Ø 5.4 - 4 mm 26193

Abutment

Uni Abutment EV Pick-up



- Ø 4.3 Short 26245
- Ø 4.3 26247
- Ø 5.5 Short 26246
- Ø 5.5 26248

Uni Abutment EV Transfer



26249

Angled Abutment EV Pick-up



26244

Attachment-retained

Abutments

Locator™ Abutment EV 4.2



- 1 mm 25662
- 2 mm 25663
- 3 mm 25664
- 4 mm 25665
- 5 mm 25666

Ball Abutment EV 4.2











- 1 mm 25690
- 2 mm 25691
- 3 mm 25692
- 4 mm 25693
- 5 mm 25694
- 7 mm 25695



















Abutment impressions







Locator™ Abutment Pick-up



24484

<p>Direct Abutment™ EV 4.2</p>  <p> Ø 5 1 mm 25367 Ø 5 2 mm 25368 Ø 5 3 mm 25369 Ø 6 1 mm 25494 Ø 6 2 mm 25495 Ø 6 3 mm 25496 </p> <p>TitaniumBase EV 4.2</p>  <p> Ø 4.7 1 mm 25928 Ø 4.7 2 mm 25929 </p>	<p>Implant impressions</p> <p>Implant Pick-Up EV</p>  <p>Short 26228 Long 26233</p> <p>Implant Transfer EV</p>  <p>Short 25537 Long 25538</p> <p>Implant Pick-Up Design EV</p>  <p>Short 26236 Long 26241</p>	<p>Lab products</p> <p>Lab Abutment Screw EV</p>  <p>25478 QTY 3</p> <p>Lab Pin Design EV</p>  <p>25530</p> <p>Implant Replica EV</p>  <p>25545</p>
---	--	--

<p>impressions</p> <p>Multibase EV Pick-up</p>  <p>26195</p> <p>Multibase EV Transfer</p>  <p>26194</p>	<p>Lab products</p> <p>Uni Abutment EV Replica</p>  <p>25615</p> <p>Angled Abutment EV Replica</p>  <p>25652</p> <p>Multibase EV Replica</p>  <p>26201</p> <p>Lab Abutment Pin EV</p>  <p>Short 25643 Intermediate 25644 Long 25645</p> <p>Lab Bridge Screw EV</p>  <p>25656 QTY 3</p> <p>Multibase EV Lab Pin</p>  <p>14 mm 26197 18 mm 26198 22 mm 26199</p>	<p>Cylinders</p> <p>Uni Abutment EV Temporary Cylinder</p>  <p>26250</p> <p>Uni Abutment EV Semi-Burnout Cylinder</p>  <p>25647</p> <p>Uni Abutment EV Burnout Cylinder</p>  <p>25649</p> <p>Angled Abutment EV Temporary Cylinder</p>  <p>25654</p> <p>Angled Abutment EV Semi-Burnout Cylinder</p>  <p>25653</p> <p>Angled Abutment EV Burnout Cylinder</p>  <p>25655</p> <p>Multibase EV Temporary Cylinder</p>  <p>26202</p> <p>Multibase EV Burnout Cylinder</p>  <p>26203</p> <p>Bridge screws</p> <p>Bridge Screw EV</p>  <p>25481</p> <p>Multibase EV Bridge Screw</p>  <p>26196</p>
---	---	---

<p>Replicas</p> <p>Locator™ Abutment Replica</p>  <p>24485</p> <p>Ball Abutment EV Replica</p>  <p>25826</p>	<p>Attachment components</p> <p>Dalbo Plus Female Part TE Basic, complete</p>  <p>25834</p> <p>Locator™ Process Kit</p>  <p>24483</p> <p>Locator™ Insert - Male</p>  <p>Blue 24488 Pink 24487 Clear 24486</p> <p>Locator™ Insert - Extended Range Male</p>  <p>Grey 25679 Red 24492 Orange 25843 Green 24489</p> <p>OD Cylinder EV</p>  <p>25638</p>
---	---

Product overview

4.8

BLUE

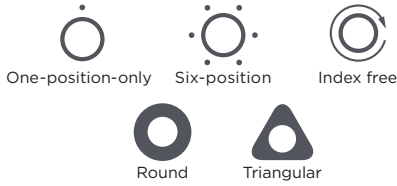

Implants

Astra Tech Implant EV 4.8 S



- 6 mm 26340
- 8 mm 26341
- 9 mm 26342
- 11 mm 26343
- 13 mm 26344
- 15 mm 26345
- 17 mm 26346

Astra Tech Implant EV 4.8 C



- 8 mm 26351
- 9 mm 26352
- 11 mm 26353
- 13 mm 26354
- 15 mm 26355
- 17 mm 26356

Cover screw



0 mm 25283

Healing abutments

HealDesign™ EV 4.8



- Ø 5.0 2.5 mm 25913
- Ø 5.0 3.5 mm 25502
- Ø 5.0 4.5 mm 25914
- Ø 5.0 6.5 mm 25915
- Ø 6.5 2.5 mm 25916
- Ø 6.5 3.5 mm 25917
- Ø 6.5 4.5 mm 25306
- Ø 6.5 6.5 mm 25798
- Ø 7.5 3.5 mm 25918
- Ø 7.5 4.5 mm 25919

- △ Ø 5.0 3.5 mm 25305
- △ Ø 6.5 3.5 mm 25307

Healing Uni EV 4.8



- Ø 4 2 mm 26219
- Ø 4 3 mm 26220
- Ø 4 4 mm 26221
- Ø 4 6 mm 26222

Cement-retained

Temporary abutments

TempDesign™ EV



Ø 10 5 mm 25506

Temp Abutment EV

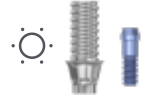

Ø 5.0 1 mm 26254

Abutments

TiDesign™ EV 4.8



- Ø 7.0 2.5 mm 25342
- Ø 5.5 20° 1.5 mm 25343
- △ Ø 5.5 1.5 mm 25340
- △ Ø 7.0 1.5 mm 25341

CastDesign™ EV 4.8



Ø 5.1 1 mm 25328

ZirDesign™ EV 4.8



- Ø 7.0 2.5 mm 25324
- Ø 5.5 20° 1.5 mm 25325
- △ Ø 5.5 1.5 mm 25322
- △ Ø 7.0 1.5 mm 25323

Screw-retained

Abutments

Uni Abutment EV 4.8

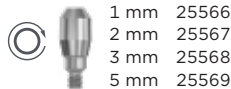

- 1 mm 25566
- 2 mm 25567
- 3 mm 25568
- 5 mm 25569

Angled Abutment EV 4.8 20°



- Ø 4.2 1 mm 25631
- Ø 4.2 2 mm 25632
- Ø 4.2 1 mm 25633
- Ø 4.2 2 mm 25634

Multibase Abutment EV 4.8

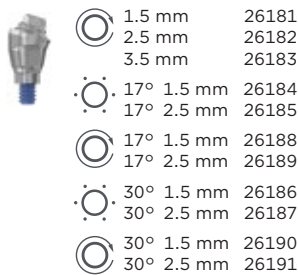

- 1.5 mm 26181
- 2.5 mm 26182
- 3.5 mm 26183
- 17° 1.5 mm 26184
- 17° 2.5 mm 26185
- 17° 1.5 mm 26188
- 17° 2.5 mm 26189
- 30° 1.5 mm 26186
- 30° 2.5 mm 26187
- 30° 1.5 mm 26190
- 30° 2.5 mm 26191

Healing caps

Uni Abutment EV Heal Cap



- Ø 4.3 Short 25952
- Ø 4.3 25616
- Ø 5.5 Short 25953
- Ø 5.5 25617

Angled Abutment EV Heal Cap



25650

Multibase EV Heal Cap



Ø 5.4 - 4 mm 26193

Abutment

Uni Abutment EV Pick-up



- Ø 4.3 Short 26245
- Ø 4.3 26247
- Ø 5.5 Short 26246
- Ø 5.5 26248

Uni Abutment EV Transfer



26249

Angled Abutment EV Pick-up



26244

Attachment-retained

Abutments

Locator™ Abutment EV 4.8



- 1 mm 25667
- 2 mm 25668
- 3 mm 25669
- 4 mm 25670
- 5 mm 25671

Ball Abutment EV 4.8











- 1 mm 25696
- 2 mm 25697
- 3 mm 25698
- 4 mm 25699
- 5 mm 25700
- 7 mm 25701



















Abutment impressions







Locator™ Abutment Pick-up



24484

<p>Direct Abutment™ EV 4.8</p>  <p> Ø 5 1 mm 25370 Ø 5 2 mm 25371 Ø 5 3 mm 25372 Ø 6 1 mm 25497 Ø 6 2 mm 25498 Ø 6 3 mm 25499 </p> <p>TitaniumBase EV 4.8</p>  <p> Ø 5.0 1 mm 25930 Ø 5.0 2 mm 25931 </p>	<p>Implant impressions</p> <p>Implant Pick-Up EV</p>  <p>Short 26229 Long 26234</p> <p>Implant Transfer EV</p>  <p>Short 25539 Long 25540</p> <p>Implant Pick-Up Design EV</p>  <p>Short 26237 Long 26242</p>	<p>Lab products</p> <p>Lab Abutment Screw EV</p>  <p>25479 QTY 3</p> <p>Lab Pin Design EV</p>  <p>25530</p> <p>Implant Replica EV</p>  <p>25546</p>
---	--	--

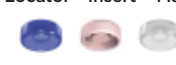
<p>impressions</p> <p>Multibase EV Pick-up</p>  <p>26195</p> <p>Multibase EV Transfer</p>  <p>26194</p>	<p>Lab products</p> <p>Uni Abutment EV Replica</p>  <p>25615</p> <p>Angled Abutment EV Replica</p>  <p>25652</p> <p>Multibase EV Replica</p>  <p>26201</p> <p>Lab Abutment Pin EV</p>  <p>Short 25643 Intermediate 25644 Long 25645</p> <p>Lab Bridge Screw EV</p>  <p>25656 QTY 3</p> <p>Multibase EV Lab Pin</p>  <p>14 mm 26197 18 mm 26198 22 mm 26199</p>	<p>Cylinders</p> <p>Uni Abutment EV Temporary Cylinder</p>  <p>26250</p> <p>Uni Abutment EV Semi-Burnout Cylinder</p>  <p>25647</p> <p>Uni Abutment EV Burnout Cylinder</p>  <p>25649</p> <p>Angled Abutment EV Temporary Cylinder</p>  <p>25654</p> <p>Angled Abutment EV Semi-Burnout Cylinder</p>  <p>25653</p> <p>Angled Abutment EV Burnout Cylinder</p>  <p>25655</p> <p>Multibase EV Temporary Cylinder</p>  <p>26202</p> <p>Multibase EV Burnout Cylinder</p>  <p>26203</p> <p>Bridge screws</p> <p>Bridge Screw EV</p>  <p>25481</p> <p>Multibase EV Bridge Screw</p>  <p>26196</p>
---	---	---

<p>Replicas</p> <p>Locator™ Abutment Replica</p>  <p>24485</p> <p>Ball Abutment EV Replica</p>  <p>25826</p>	<p>Attachment components</p> <p>Dalbo Plus Female Part TE Basic, complete</p>  <p>25834</p> <p>Locator™ Process Kit</p>  <p>24483</p> <p>Locator™ Insert - Male</p>  <p>Blue 24488 Pink 24487 Clear 24486</p> <p>Locator™ Insert - Extended Range Male</p>  <p>Grey 25679 Red 24492 Orange 25843 Green 24489</p> <p>OD Cylinder EV</p>  <p>25638</p>
---	---

Product overview

5.4

BROWN

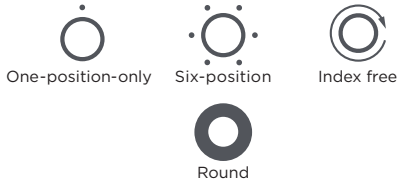

Implants

Astra Tech Implant EV 5.4 S



- 6 mm 26360
- 8 mm 26361
- 9 mm 26362
- 11 mm 26363
- 13 mm 26364
- 15 mm 26365

Cover screw



- 0 mm 25284

Healing abutments

HealDesign™ EV 5.4



- ⊙ Ø 6.5 2.5 mm 25921
- ⊙ Ø 6.5 3.5 mm 25309
- ⊙ Ø 6.5 4.5 mm 25308
- ⊙ Ø 6.5 6.5 mm 25799
- ⊙ Ø 7.5 3.5 mm 25922
- ⊙ Ø 7.5 4.5 mm 25923

Healing Uni EV 5.4



- ⊙ Ø 4 2 mm 26223
- ⊙ Ø 4 3 mm 26224
- ⊙ Ø 4 4 mm 26225
- ⊙ Ø 4 6 mm 26226

Cement-retained

Temporary abutments

TempDesign™ EV



- ⊙ 10 5 mm 25507

Temp Abutment EV



- ⊙ 5.5 1 mm 26255

Abutments

TiDesign™ EV 5.4



- ⊙ Ø 7.0 2.5 mm 25344
- ⊙ Ø 7.0 1.5 mm 25345

CastDesign™ EV 5.4



- ⊙ Ø 5.1 1 mm 25329

Screw-retained

Abutments

Uni Abutment EV 5.4



- 1 mm 25570
- 2 mm 25571
- 3 mm 25572
- 5 mm 25573

Healing caps

Uni Abutment EV
Heal Cap



- ⊙ 4.3 Short 25952
- ⊙ 4.3 25616
- ⊙ 5.5 Short 25953
- ⊙ 5.5 25617









Abutment

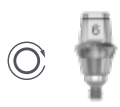







Uni Abutment EV
Pick-up



- ⊙ 4.3 Short 26245
- ⊙ 4.3 26247
- ⊙ 5.5 Short 26246
- ⊙ 5.5 26248

Note: Atlantis patient-specific prosthetic solutions are available.
Speak with your local Dentsply Sirona Implants representative for more information.

<p>Direct Abutment™ EV 5.4</p>  <p> Ø 6 1 mm 25373 Ø 6 2 mm 25374 Ø 6 3 mm 25375 </p> <p>TitaniumBase EV 5.4</p>  <p> Ø 5.5 1 mm 25932 Ø 5.5 2 mm 25933 </p>	<p>Implant impressions</p> <p>Implant Pick-Up EV</p>  <p>Short 26230</p> <p>Implant Transfer EV</p>  <p>Short 25541 Long 25542</p> <p>Implant Pick-Up Design EV</p>  <p>Short 26238 Long 26243</p>	<p>Lab products</p> <p>Lab Abutment Screw EV</p>  <p>25480 QTY 3</p> <p>Lab Pin Design EV</p>  <p>25530</p> <p>Implant Replica EV</p>  <p>25547</p>
---	---	--

<p>impressions</p> <p>Uni Abutment EV Transfer</p>  <p>26249</p>	<p>Lab products</p> <p>Uni Abutment EV Replica</p>  <p>25615</p> <p>Lab Abutment Pin EV</p>  <p>Short 25643 Intermediate 25644 Long 25645</p> <p>Lab Bridge Screw EV</p>  <p>25656 QTY 3</p>	<p>Bridge screw</p> <p>Bridge Screw EV</p>  <p>25481</p>	<p>Cylinders</p> <p>Uni Abutment EV Temporary Cylinder</p>  <p>26250</p> <p>Uni Abutment EV Semi-Burnout Cylinder</p>  <p>25647</p> <p>Uni Abutment EV Burnout Cylinder</p>  <p>25649</p>
--	---	--	--

Introduction



The design philosophy of the Astra Tech Implant System EV is based on the natural dentition. This site-specific, prosthetic driven approach is supported by a flexible surgical protocol and a simple prosthetic workflow, providing increased confidence and satisfaction for all members of the treatment team.

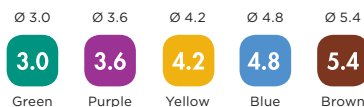

Astra Tech Implant EV Profile

Recommended implant size(s) in relation to tooth position, provided there is sufficient bone volume and space in relation to the adjacent dentition.



The foundation for Astra Tech Implant System EV is the unique **Astra Tech Implant System BioManagement Complex**, well-documented for its long-term marginal bone maintenance and esthetic results.

Dentsply Sirona warranty program* — We have you covered



*For full terms and conditions, refer to the "Implant Systems Warranty" flyer.

Surgery

Versatile implant assortment

The implants are available in a versatile range of shapes, diameters and lengths for all indications, including situations with limited space and/or bone quantity.



Flexible drilling protocol that allows for preferred primary stability

The drilling procedure is made easy by using color-coding and a simple numbering system.



Site-specific components

Including round and triangular healing abutments.



Color-coded assortment

Each implant-abutment connection size is identified by a specific color, which is used consistently throughout the system. The color is applied directly to components and instruments, as well as on packaging and informational material, where appropriate.



Three peel-off labels are provided for the patient's treatment record and for communicating with the restorative team.

For specific procedural details, please refer to the respective manual.

Implants

Astra Tech Implant EV

Titanium (I), sterile

Astra Tech Implant EV implants are available in a versatile range of shapes, diameters and lengths for all indications, including situations with limited space and/or bone quantity.

S = Straight

C = Conical



Specific colors have been assigned to the different implant-abutment connection sizes, which are consistently used throughout the system.

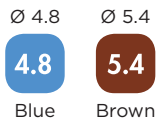
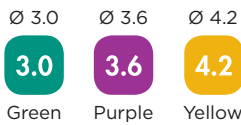

- Implants for all indications in both the anterior and posterior region.
- For further details - see Instructions for use or Surgical manual.
- OsseoSpeed surface treatment over the entire implant to the top of the first microthreads.
- For conical implants the body portion is 0.6 mm narrower.

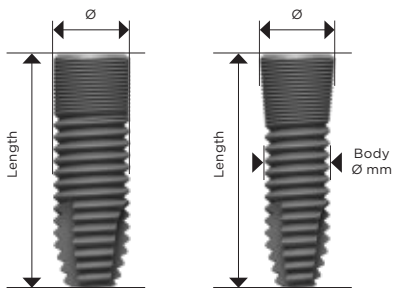

3.0 Astra Tech Implant EV 3.0 S



Ø mm		3.0	3.0	3.0	3.0	3.0
Length mm		8	9	11	13	15
Order No.		26301	26302	26303	26304	26305

3.6 Astra Tech Implant EV 3.6 S



Ø mm	3.6	3.6	3.6	3.6	3.6	3.6	3.6
Length mm	6	8	9	11	13	15	17
Order No.	26310	26311	26312	26313	26314	26315	26316

4.2 Astra Tech Implant EV 4.2 S



Ø mm	4.2	4.2	4.2	4.2	4.2	4.2	4.2
Length mm	6	8	9	11	13	15	17
Order No.	26320	26321	26322	26323	26324	26325	26326

4.2 Astra Tech Implant EV 4.2 C



Ø mm		4.2	4.2	4.2	4.2	4.2	4.2
Body Ø mm		3.6	3.6	3.6	3.6	3.6	3.6
Length mm		8	9	11	13	15	17
Order No.		26331	26332	26333	26334	26335	26336

4.8 Astra Tech Implant EV 4.8 S



Ø mm	4.8	4.8	4.8	4.8	4.8	4.8	4.8
Length mm	6	8	9	11	13	15	17
Order No.	26340	26341	26342	26343	26344	26345	26346

4.8 Astra Tech Implant EV 4.8 C



Ø mm		4.8	4.8	4.8	4.8	4.8	4.8
Body Ø mm		4.2	4.2	4.2	4.2	4.2	4.2
Length mm		8	9	11	13	15	17
Order No.		26351	26352	26353	26354	26355	26356

5.4 Astra Tech Implant EV 5.4 S



Ø mm	5.4	5.4	5.4	5.4	5.4	5.4
Length mm	6	8	9	11	13	15
Order No.	26360	26361	26362	26363	26364	26365

Cover Screw EV

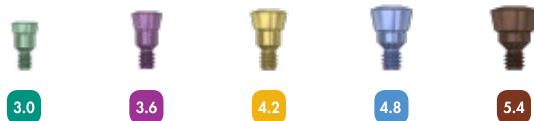

Order No.	25280	25281	25282	25283	25284
-----------	-------	-------	-------	-------	-------

Cover Screw EV
Titanium (2), sterile



Healing abutments

HealDesign™ EV

Titanium (2), sterile

- For soft tissue sculpturing during the healing phase
- Can be used for both one- and two-stage surgery
- Design is primarily matched to TiDesign EV and ZirDesign EV abutments
- Heights and diameters are harmonized with the permanent abutments as well as with the tooth position
 - Round shapes are indicated for all positions in the mouth.
 - △ Triangular shapes are designed for anterior implant sites and mimic the specific shape for incisors and canines. Triangular HealDesign™ EV is a two-piece abutment.
- Marked with diameter and height

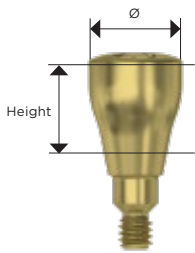

*Compatible with Astra Tech Implant EV Profile

3.0 HealDesign™ EV 3.0

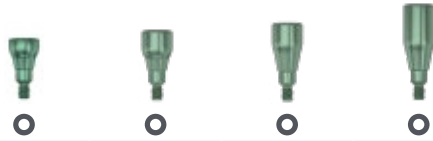

Ø mm	3.5	3.5	3.5	3.5
Height mm	2.5	3.5	4.5	6.5
Order No.	25901	25298	25297	25795

3.6 HealDesign™ EV 3.6



Ø mm	4	4	4	4	5	5	5	5	6	6	5
Height mm	2.5	3.5	4.5	6.5	2.5	3.5	4.5	6.5	3.5	4.5	3.5
Order No.	25902	25300	25299	25796	25903	25920	25904	25905	25906	25907	25301

4.2 HealDesign™ EV 4.2

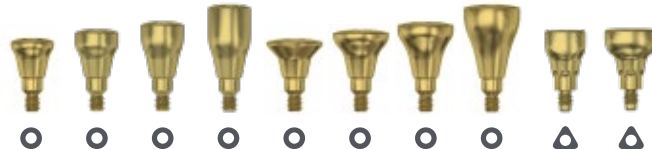

Ø mm	5	5	5	5	6.5	6.5	6.5	6.5	5	6.5
Height mm	2.5	3.5	4.5	6.5	2.5	3.5	4.5	6.5	3.5	3.5
Order No.	25908*	25501*	25302*	25797*	25909*	25910*	25911*	25912*	25303	25304

4.8 HealDesign™ EV 4.8



Ø mm	5	5	5	5	6.5	6.5	6.5	6.5	7.5	7.5	5	6.5
Height mm	2.5	3.5	4.5	6.5	2.5	3.5	4.5	6.5	3.5	4.5	3.5	3.5
Order No.	25913*	25502*	25914*	25915*	25916*	25917*	25306*	25798*	25918*	25919*	25305	25307

5.4 HealDesign™ EV 5.4



Ø mm	6.5	6.5	6.5	6.5	7.5	7.5
Height mm	2.5	3.5	4.5	6.5	3.5	4.5
Order No.	25921	25309	25308	25799	25922	25923

3.0 Healing Uni EV 3.0



Ø mm	4	4	4	4
Height mm	2	3	4	6
Order No.	25574	25575	25576	25577

3.6 Healing Uni EV 3.6

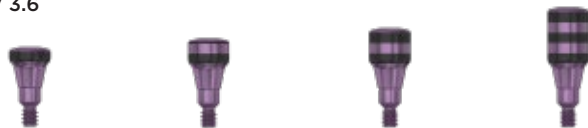

Ø mm	4	4	4	4
Height mm	2	3	4	6
Order No.	25285	25578	25286	25287

4.2 Healing Uni EV 4.2



Ø mm	4	4	4	4
Height mm	2	3	4	6
Order No.	25288*	25579*	25289*	25290*

4.8 Healing Uni EV 4.8

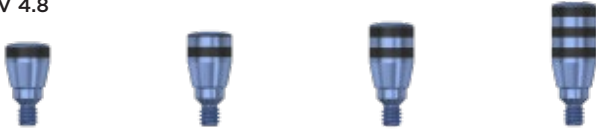

Ø mm	4.3	4.3	4.3	4.3
Height mm	2	3	4	6
Order No.	26219*	26220*	26221*	26222*

5.4 Healing Uni EV 5.4



Ø mm	4.8	4.8	4.8	4.8
Height mm	2	3	4	6
Order No.	26223	26224	26225	26226

Healing Uni EV

Titanium (2), sterile

- Promotes soft tissue sculpturing primarily for Uni Abutment EV
- Laser etched bands for gauging
- Marked with height

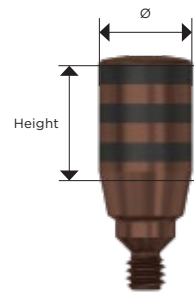

*Compatible with Astra Tech Implant EV Profile

Prosthetics

Site-specific restorative components

Including round and triangular options.



Self-guiding impression components

Supports all indexing options; one-position-only, six positions and index free.

One system - one torque

All final abutments are designed for one tightening torque value of 25 Ncm for simplicity.



One interface - three indexing solutions



One-position-only



Six-position



Index free

The Astra Tech Implant EV has a unique interface for one-position-only placement for restorative procedures and components, e.g. the Atlantis patient-specific, abutments. The interface also allows for the flexibility of six-position indexing of prefabricated abutments, while index-free abutments can be seated in any rotational position.

For specific procedural details, please refer to the respective manual.

Temporary abutments – implant-level

TempDesign™ EV



Ø mm	6	7	9	10	10
Margin height mm	5	5	5	5	5
Vert. height mm	10	12	12	12	10
Order No.	25503	25504	25505	25506	25507

TempDesign™ EV

Titanium (2)-PEEK plastic (10), non-sterile, delivered with an abutment screw

- Anatomically pre-designed for reduction technique
- For both screw- and cement-retained restorations
- Can be processed at the laboratory or chairside
- Temporary use; max 180 days
- Screw-retained restorations, limited to single-tooth only
- Indexed abutments will seat in six available positions.

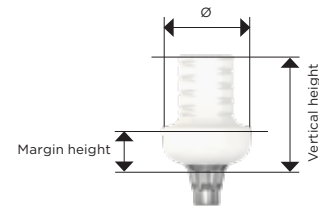

Temp Abutment EV



Ø mm	3.3	4.0	4.5	5.0	5.5
Margin height mm	1	1	1	1	1
Vert. height mm	9	9	9	9	9
Order No.	26251	26252	26253	26254	26255

Temp Abutment EV

Titanium (2), non-sterile, delivered with an abutment screw

- Designed for build-up technique
- For large, multi-unit restorations and/or long-term temporization
- For both screw- and cement-retained restorations
- Primarily processed in the laboratory
- Screw-retained restorations, limited to single-tooth only
- Indexed abutments will seat in six available positions.

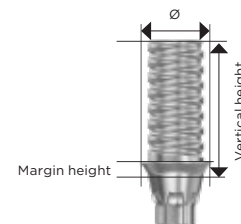

Abutment Screw EV



	M1.4	M1.6	M1.8	M2.0	M2.0
Order No.	25203	25204	25205	25206	25207

Abutment Screw EV





Titanium (2), non-sterile

Note: A corresponding Abutment Screw EV is included with every temporary abutment as well as final two-piece abutments. To order additional screws, refer to Abutment Screw EV section to the left.

Cement-retained restorations – implant-level

TiDesign™ EV

Titanium (2), non-sterile, delivered with an abutment screw

-  Round - design for the majority of restorative situations
-  Triangular - primarily for incisors and canines with triangular shape; low margin of 1.5 mm above implant level
-  Angled design for offset situations compensating for implants in a restoratively unfavorable position
-  Indexed abutments will seat in six available positions.
-  Marked with Ø

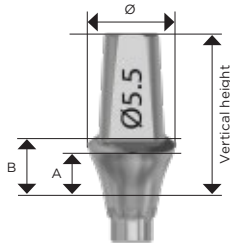

A = buccal height
B = lingual height



Note: A corresponding Abutment Screw EV is included with every two-piece final abutment. To order additional screws, refer to Abutment Screw EV section (p.21).

3.0 TiDesign™ EV 3.0



Ø mm	4	4	4
A - height bucc mm	2.5	1.5	1.5
B - height ling mm	3.5	2.5	2.5
Vertical height mm	8	7	7
Order No.	25330	25331	25332

3.6 TiDesign™ EV 3.6



Ø mm	4.5	4.5	5.5
A - height bucc mm	2.5	1.5	1.5
B - height ling mm	3.5	2.5	2.5
Vertical height mm	10	9	9
Order No.	25334	25335	25333

4.2 TiDesign™ EV 4.2



Ø mm	5.5	5.5	5.5	7
A - height bucc mm	2.5	1.5	1.5	1.5
B - height ling mm	3.5	2.5	2.5	2.5
Vertical height mm	10	9	9	9
Order No.	25338	25339	25336	25337

4.8 TiDesign™ EV 4.8

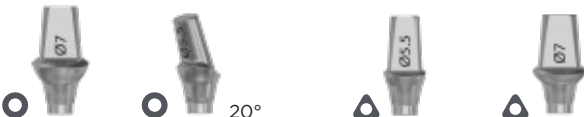

Ø mm	7	5.5	5.5	7
A - height bucc mm	2.5	1.5	1.5	1.5
B - height ling mm	3.5	2.5	2.5	2.5
Vertical height mm	10	9	9	9
Order No.	25342	25343	25340	25341

5.4 TiDesign™ EV 5.4



Ø mm	7	7
A - height bucc mm	2.5	1.5
B - height ling mm	3.5	2.5
Vertical height mm	10	9
Order No.	25344	25345

3.6 ZirDesign™ EV 3.6



Ø mm	4.5	4.5	5.5
A - height bucc mm	2.5	1.5	1.5
B - height ling mm	3.5	2.5	2.5
Vertical height mm	10	9	9
Order No.	25316	25317	25315

4.2 ZirDesign™ EV 4.2

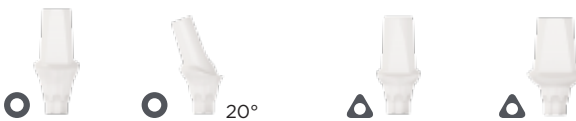

Ø mm	5.5	5.5	5.5	7
A - height bucc mm	2.5	1.5	1.5	1.5
B - height ling mm	3.5	2.5	2.5	2.5
Vertical height mm	10	9	9	9
Order No.	25320	25321	25318	25319

4.8 ZirDesign™ EV 4.8



Ø mm	7	5.5	5.5	7
A - height bucc mm	2.5	1.5	1.5	1.5
B - height ling mm	3.5	2.5	2.5	2.5
Vertical height mm	10	9	9	9
Order No.	25324	25325	25322	25323

ZirDesign™ EV

Zirconia (18), non-sterile, delivered with an abutment screw

- Round - design for the majority of restorative situations
- Triangular - primarily for incisors and canines with triangular shape; low margin of 1.5 mm above implant level
- Angled design for offset situations compensating for implants in a restoratively unfavorable position
- Indexed abutments will seat in six available positions.

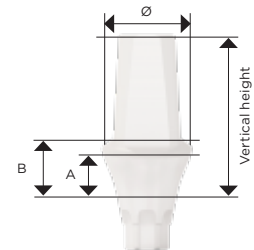

A = buccal height
B = lingual height



CastDesign™ EV



Ø mm	4.1	4.1	5.1	5.1
Height mm	1	1	1	1
Vertical height mm	11	11	11	11
Order No.	25326	25327	25328	25329

CastDesign™ EV

Metal Base: Gold-Platinum alloy (3)
Cylinder: PMMA burnout plastic (11)
Non-sterile, delivered with an abutment screw

For cases that require angulation corrections up to 30° using regular wax-up and cast-to techniques

- For both screw- and cement-retained restorations
- Screw-retained restorations, limited to single-tooth only
- Indexed abutments will seat in six available positions.

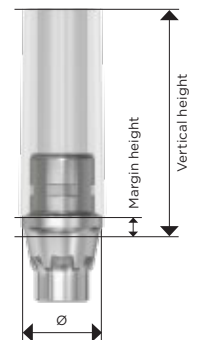

TitaniumBase EV

Titanium (2), non-sterile, delivered with an abutment screw

- For temporary and final cement- / screw-retained restorations
 - Screw-retained restorations, limited to single-tooth only
- Single and partial situations, all positions in the mouth
- TitaniumBase EV is provided with two flattened sides forming an anti-rotational feature
- Indexed abutments will seat in six available positions

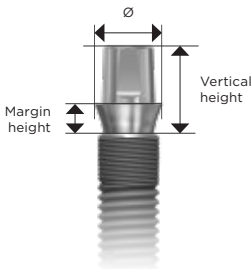

3.0 TitaniumBase EV 3.0



Ø mm	4	4
Margin height mm	1	2
Vertical height mm	5	6
Order No.	25924	25925

3.6 TitaniumBase EV 3.6



Ø mm	4.1	4.1
Margin height mm	1	2
Vertical height mm	5	6
Order No.	25926	25927

4.2 TitaniumBase EV 4.2



Ø mm	4.7	4.7
Margin height mm	1	2
Vertical height mm	5	6
Order No.	25928	25929

4.8 TitaniumBase EV 4.8



Ø mm	5	5
Margin height mm	1	2
Vertical height mm	5	6
Order No.	25930	25931

5.4 TitaniumBase EV 5.4



Ø mm	5.5	5.5
Margin height mm	1	2
Vertical height mm	5	6
Order No.	25932	25933

Digital Workflow

To be able to work with a digital workflow, a digital library is needed.

The digital library includes all necessary information of the implant system, TitaniumBase and scanbody to use

- Atlantis FLO/IO FLO
- 3Shape scanbody
- Elos Accurate scanbody/model analog.

Enables the design software to create a sufficient output to produce the restoration onto the TitaniumBase.

Download the libraries for 3Shape or Exocad from the Dentsply Sirona e-Commerce.

Components and instruments for scanning of implants

Atlantis® FLO

For lab-based scanning of implants



	3.0	3.6	4.2	4.8	5.4
FLO code	P-01	P-02	P-03	P-04	P-05
Order No.	34593	34594	34595	34596	34597

Atlantis® FLO screwdriver

Required for Atlantis FLO, used with lab-based scanning



Order No.	34601
-----------	-------

Atlantis® IO FLO

For intraoral scanning of implants. To be used with Hex Screwdriver EV.



	3.0	3.6	4.2	4.8	5.4
IO FLO code	IO P-01	IO P-02	IO P-03	IO P-04	IO P-05
Order No.	35243	35244	35245	35246	35247

Impression and laboratory components – implant-level

Implant Pick-Up EV, Short

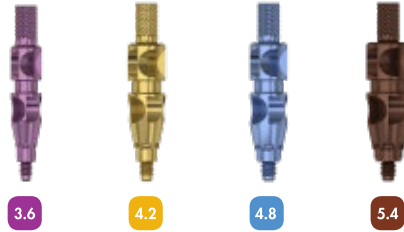

Ø mm	3.8	4.6	4.6	5.4
Height mm	16.5	16.5	16.5	16.5
Order No.	26227	26228	26229	26230

Implant Pick-Up EV / Implant Pick-Up Design EV

Titanium (2), non-sterile

- Open tray technique
- Self-guiding positioning
- Designed with hex at the pin head
- Possibilities to capture the exact soft tissue shape for best possible esthetic results
- Supports all indexing options; one-position-only, six position and indexed free
- Designed for splinting possibilities

Implant Pick-Up EV, Long



Ø mm	3.3	3.8	4.6	4.6
Height mm	22	22	22	22
Order No.	26231	26232	26233	26234

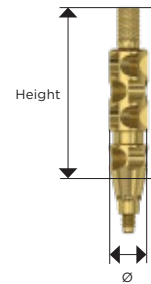

Implant Pick-Up Design EV, Short



Ø mm	3.6	4.2	4.8	5.4
Height mm	16.7	16.7	16.7	16.7
Order No.	26235	26236	26237	26238



Implant Pick-Up Design EV, Long



Ø mm	3.0	3.6	4.2	4.8	5.4
Height mm	22	22	22	22	22
Order No.	26239	26240	26241	26242	26243

Implant Transfer EV

Titanium (2), non-sterile

- Closed tray technique
- Self-guiding positioning
- Must be repositioned in the unique site in the impression
- Designed with a hex at the pin head

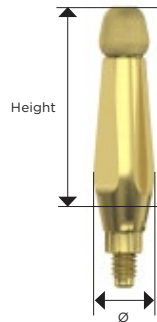

Implant Transfer EV, Short



∅ mm		3.6	4.2	4.8	5.4
Height mm		11	11	11	11
Order No.		25535	25537	25539	25541

Implant Transfer EV, Long



∅ mm	3.5	3.6	4.2	4.8	5.4
Height mm	14	14	14	14	14
Order No.	25534	25536	25538	25540	25542

Implant Replica EV

Titanium (2), non-sterile

Adjustment of apex allow for removal of replica from master model without need for sectioning

- Single use

Implant Replica EV



Height mm	16.5	16.5	16.5	16.5	16.5
Order No.	25543	25544	25545	25546	25547

Lab Pin Design EV

Stainless steel (6), non-sterile

- For maintenance of screw access channel during the laboratory procedure
- Friction fit to the Lab Abutment Screw EV screw hole

Lab Abutment Screw EV

Titanium (2), non-sterile

QTY 3

Designed for use with Implant Replica EV only

Lab Pin Design EV



Height mm	25	25
Order No.	25528	25530

Lab Abutment Screw EV



Order No.	25476	25477	25478	25479	25480
-----------	-------	-------	-------	-------	-------

Cement-retained restorations – abutment-level

3.0 Direct Abutment™ EV 3.0



Ø mm	3.3	3.3	3.3
Margin height mm	1	2	3
Vert. height mm	6	7	8
Order No.	25361	25362	25363

3.6 Direct Abutment™ EV 3.6



Ø mm	4.0	4.0	4.0
Margin height mm	1	2	3
Vert. height mm	6	7	8
Order No.	25364	25365	25366

Direct Driver EV Ø3.3 Ø4



Length mm	26
Order No.	25764

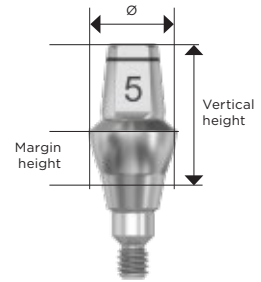

Direct Abutment™ EV

Titanium (2), sterile

- Sold separately; not included in the Direct EV API™ kit
-  Index-free abutments will be seated in any rotational position.
- Marked with Ø

Direct Driver EV Ø3.3 Ø4

Stainless steel (6), non-sterile

Required for carrying and installation of Direct Abutment EV Ø 3.3 and Ø 4.0 only.

4.2 Direct Abutment™ EV 4.2



Ø mm	5.0	5.0	5.0	6.0	6.0	6.0
Margin height mm	1	2	3	1	2	3
Vert. height mm	6	7	8	6	7	8
Order No.	25367*	25368*	25369*	25494*	25495*	25496*

Hex Driver EV

Stainless steel (6), non-sterile

Use the Hex Driver EV for the Ø 5.0 and Ø 6.0 Direct Abutment™ EV.

4.8 Direct Abutment™ EV 4.8



Ø mm	5.0	5.0	5.0	6.0	6.0	6.0
Margin height mm	1	2	3	1	2	3
Vert. height mm	6	7	8	6	7	8
Order No.	25370*	25371*	25372*	25497*	25498*	25499*

5.4 Direct Abutment™ EV 5.4



Ø mm	6.0	6.0	6.0
Margin height mm	1	2	3
Vert. height mm	6	7	8
Order No.	25373	25374	25375



*Compatible with Astra Tech Implant EV Profile

Direct EV API™

Non-sterile

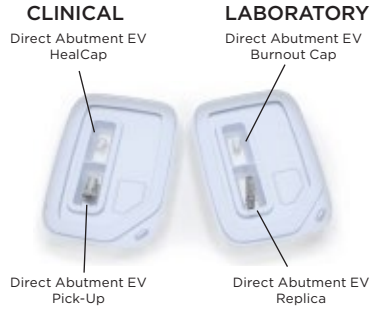

Direct EV API™



Ø mm	3.3	4	5	6
Order No.	25346	25347	25348	25349

Contains all corresponding components for working with the Direct Abutment EV

- Two compartments for clinical and laboratory components respectively
- Direct Abutment EV must be ordered separately

Direct Abutment™ EV HealCap

PC plastic (12), non-sterile

- Temporary use; maximum 30 days

Direct Abutment™ EV HealCap



Ø mm	3.3	4	5	6
Order No.	25310	25311	25312	25313

Direct Abutment™ EV Pick-Up

PP plastic (13), non-sterile

- DA EV Pick-Up Ø3.3 and Ø6 – transparent
- DA EV Pick-Up Ø4 – white
- DA EV Pick-Up Ø5 – grey

Direct Abutment™ EV Pick-Up



Ø mm	3.3	4	5	6
Order No.	25396	25397	25398	25399

Direct Abutment™ EV Replica

Titanium (2), non-sterile

- Single use

Direct Abutment™ EV Replica



Ø mm	3.3	4	5	6
Order No.	25401	25402	25403	25404

Direct Abutment™ EV Burnout Cap

PMMA Burn-out Plastic (11), non-sterile

Direct Abutment™ EV Burnout Cap



Ø mm	3.3	4	5	6
Order No.	25406	25407	25408	25409

Screw-retained restorations - abutment-level

3.0 Uni Abutment EV 3.0



A/B - Ø mm	3.6	3.6	3.6
Height mm	2	3	5
Vertical height mm	3.2	4.2	6.2
Order No.	25555	25556	25557

Uni Driver EV



Length mm	21.5
Order No.	25708

Uni Driver EV

Stainless steel (6), non-sterile

- For placing and removing Uni Abutment EV
- Use with restorative driver handle and Torque Wrench EV, page 49
- Uni Driver EV has a hexagon on the shaft, needed to meet the removal torques. For removal of Uni Abutment EV, used together with surgical driver handle, page 49

3.6 Uni Abutment EV 3.6



A/B - Ø mm	3.6	3.6	3.6	3.6
Height mm	1	2	3	5
Vertical height mm	2.2	3.2	4.2	6.2
Order No.	25558	25559	25560	25561

Uni Abutment EV

Titanium (2), sterile

- Supporting multiple unit restorations only
- Design facilitates non-parallel implant situations up to 66°
- Same top cone for all platforms
- Index-free abutments will be seated in any rotational position
- Uni Driver EV required for carrying, installation and removal

4.2 Uni Abutment EV 4.2



A/B - Ø mm	3.6	3.6	3.6	3.6
Height mm	1	2	3	5
Vertical height mm	2.2	3.2	4.2	6.2
Order No.	25562*	25563*	25564*	25565*

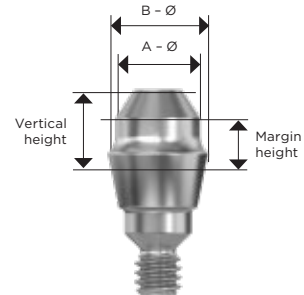

4.8 Uni Abutment EV 4.8



A - Ø mm	3.6	3.6	3.6	3.6
B - Ø mm	4.3	4.3	4.3	4.3
Height mm	1	2	3	5
Vertical height mm	2.2	3.2	4.2	6.2
Order No.	25566*	25567*	25568*	25569*

5.4 Uni Abutment EV 5.4



A - Ø mm	3.6	3.6	3.6	3.6
B - Ø mm	4.8	4.8	4.8	4.8
Height mm	1	2	3	5
Vertical height mm	2.2	3.2	4.2	6.2
Order No.	25570	25571	25572	25573





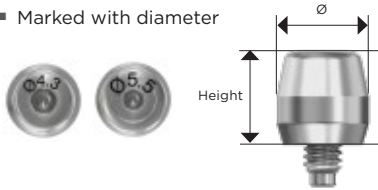

*Compatible with Astra Tech Implant EV Profile

Uni Abutment EV Heal Cap
Titanium (2), sterile, one-piece

- Marked with diameter





Uni Abutment EV	Heal Cap Short	Heal Cap	Heal Cap Short	Heal Cap
				
Ø mm	4.3	4.3	5.5	5.5
Vert. height mm	3.4	4.4	3.4	4.4
Order No.	25952	25616	25953	25617

Ø mm	4.3	4.3	5.5	5.5
Vert. height mm	3.4	4.4	3.4	4.4
Order No.	25952	25616	25953	25617

Uni Abutment EV Pick-Up and Transfer
Stainless steel (6), non-sterile

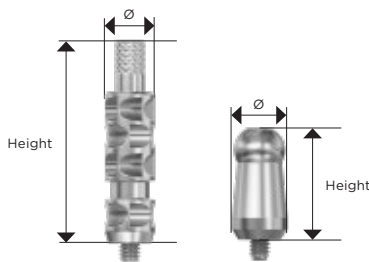
- Design for splinting possibilities
- Designed with a hex for tightening



Uni Abutment EV	Pick-Up Short	Pick-Up	Pick-Up Short	Pick-Up	Transfer
					
open tray technique					
closed tray technique					
Ø mm	4.3	4.3	5.5	5.5	4.7
Vert. height mm	14.7	17.6	14.7	17.6	9.7
Order No.	26245	26247	26246	26248	26249

Ø mm	4.3	4.3	5.5	5.5	4.7
Vert. height mm	14.7	17.6	14.7	17.6	9.7
Order No.	26245	26247	26246	26248	26249

Uni Abutment EV Replica
Stainless steel (6), non-sterile

- Single use

Temporary Cylinder Titanium (2), non-sterile

Semi-Burnout Cylinder

Metal Base: Gold-Platinum alloy (3)
Cylinder: PMMA burnout plastic (11), non-sterile

Burnout Cylinder

PMMA burnout plastic (11), non-sterile

Note: Bridge screws needs to be ordered separately.

Uni Abutment EV	Replica	Temporary Cylinder	Semi-Burnout Cylinder	Burnout Cylinder
				
Ø mm	3.6	4.4	4.4	4.2
Order No.	25615	26250	25647	25649

Ø mm	3.6	4.4	4.4	4.2
Order No.	25615	26250	25647	25649

Bridge Screw EV

Titanium (2), non-sterile

- M1.8, anodized (light blue)

Lab Bridge Screw EV

Titanium (2), non-sterile
QTY 3

Lab Abutment Pin EV

Stainless steel (6), non-sterile

- For maintenance of screw access channel
- Fits the Uni Abutment EV Replica

Bridge Screw EV	Lab Bridge Screw EV	Lab Abutment Pin EV	Short	Inter-mediate	Long	
						
Screw head height mm	1.6	1.6				
Screw head Ø mm	2.35	2.35				
Order No.	25481	25656				
			Length mm	14	18	22
			Order No.	25643	25644	25645

Screw head height mm	1.6	1.6
Screw head Ø mm	2.35	2.35
Order No.	25481	25656

Length mm	14	18	22
Order No.	25643	25644	25645

3.6 Angled Abutment EV 3.6, 20°



Margin height mm	1	2	1	2
Vertical height mm	6	7	6	7
Order No.	25619	25620	25621	25622

4.2 Angled Abutment EV 4.2, 20°



Margin height mm	1	2	1	2
Vertical height mm	6	7	6	7
Order No.	25625	25626	25627	25628

4.8 Angled Abutment EV 4.8, 20°



Margin height mm	1	2	1	2
Vertical height mm	6	7	6	7
Order No.	25631	25632	25633	25634

Angled Abutment EV

Titanium (2), sterile, delivered with an abutment screw

- Supporting multiple unit restorations only
- Same top cone for all platforms
- Indexed abutments will seat in six available positions.
- Index-free abutments will be seated in any rotational position.

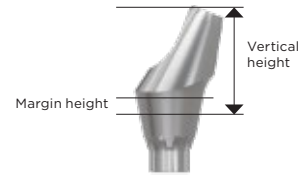

Note: A corresponding abutment screw is included with every Angled Abutment EV. To order additional screws, refer to Abutment Screw EV section (p.21).

Angled Abutment EV Heal Cap



Pick-Up
open tray technique



Replica



Angled Abutment EV HealCap

Titanium (2), sterile, two-piece

Angled Abutment EV Pick-Up

Stainless steel (6), non-sterile

Angled Abutment EV Replica

Stainless steel (6), non-sterile

- Single use

Vertical height mm	9	12	17
Order No.	25650	26244	25652

Angled Abutment EV Temporary Cylinder



Semi-Burnout Cylinder



Burnout Cylinder



Temporary Cylinder

Titanium (2), non-sterile

Semi-Burnout Cylinder

Metal Base: Gold-Platinum alloy (3)
Cylinder: PMMA burnout plastic (11), non-sterile

Burnout Cylinder

PMMA burnout plastic (11), non-sterile

Note: Bridge screws needs to be ordered separately.

Order No.	25654	25653	25655
-----------	-------	-------	-------

SmartFix® concept

Multibase Abutment EV, straight and angled



Titanium (2) with a PEEK plastic (10) holder, sterile

- Supporting multiple unit, screw-retained restorations only
- Top cone (21°) enables bridge insertion on non-parallel abutments up to 42°
- Same prosthetic interface and components for all abutments
- Delivered with a plastic holder pre-mounted to the abutment for easy installation

Multibase Abutment EV, straight

- One-piece abutment
-  Index-free abutments can be seated in any rotational position
- Holder straight has 8 identification grooves
- Multibase Driver EV required for installation and removal

Multibase Abutment EV, 17°/30°

- Consists of three parts; abutment body and a separate head part, delivered with a pre-assembled abutment screw
-  Indexed abutments can be seated in six available positions. Not compatible with OsseoSpeed Profile EV
-  Index-free abutments can be seated in any rotational position
- The abutment head part is pre-mounted on the holder
- Holder 17° has 4 identification grooves
- Holder 30° has 6 identification grooves
- Hex Driver EV required for installing the abutment screw and Multibase Driver EV for tightening the abutment head to the abutment body



*Compatible with Astra Tech Implant EV Profile

3.6 Multibase Abutment EV



A - height mm	1.5	2.5	3.5
Order No.	26159	26160	26161

3.6 Multibase Abutment EV 17°



A - height mm	1.5	2.5	1.5	2.5
B - height mm	3	4	3	4
Order No.	26162	26163	26166	26167

3.6 Multibase Abutment EV 30°



A - height mm	1.5	2.5	1.5	2.5
B - height mm	4	5	4	5
Order No.	26164	26165	26168	26169

4.2 Multibase Abutment EV



A - height mm	1.5	2.5	3.5
Order No.	26170*	26171*	26172*

4.2 Multibase Abutment EV 17°



A - height mm	1.5	2.5	1.5	2.5
B - height mm	3	4	3	4
Order No.	26173	26174	26177*	26178*

4.2 Multibase Abutment EV 30°



A - height mm	1.5	2.5	1.5	2.5
B - height mm	4	5	4	5
Order No.	26175	26176	26179*	26180*

4.8 Multibase Abutment EV



A - height mm	1.5	2.5	3.5
Order No.	26181*	26182*	26183*

4.8 Multibase Abutment EV 17°



A - height mm	1.5	2.5	1.5	2.5
B - height mm	3	4	3	4
Order No.	26184	26185	26188*	26189*

4.8 Multibase Abutment EV 30°



A - height mm	1.5	2.5	1.5	2.5
B - height mm	4	5	4	5
Order No.	26186	26187	26190*	26191*



* Compatible with OsseoSpeed Profile EV

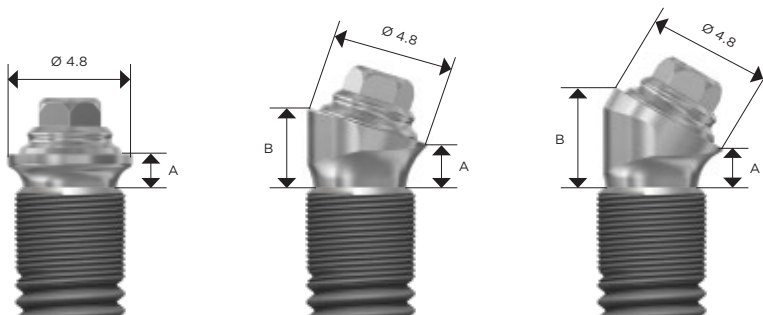

Multibase Driver EV



Total length mm	19
Order No.	26204

Multibase Driver EV

Stainless steel (6), non-sterile

- Used for installation and removal of the Multibase EV Abutment
- The Surgical Driver Handle could be useful when removing the abutment to support the torque transferring

Spare parts

Multibase EV Abutment Head with holder



Order No.	26192
-----------	-------

Multibase EV Abutment Head with holder

Titanium (2) with a PEEK plastic (10) holder, sterile

- The head part is pre-mounted on the holder
- Multibase Abutment EV 17° and 30° use the same spare part

Applicable restorative components are marked with a groove or laser marking to differentiate from other similar components of the Astra Tech Implant System EV

Multibase EV Heal Cap

Titanium (2), sterile, one-piece

- Marked with diameter and a laser ring for identification

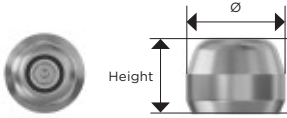

Multibase EV Heal Cap



Ø mm	5.4
Vert. height mm	4
Order No.	26193

Multibase EV Pick-up and Transfer

Stainless steel (6), non-sterile

- Pick-up two-piece, with a pronounced groove for splinting possibility
- Transfer two-piece
- Marked with a groove for identification

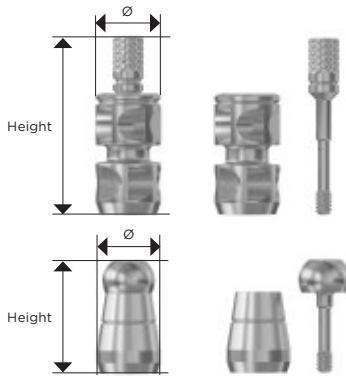

Multibase EV

Pick-up
open tray technique

Transfer
closed tray technique



Ø mm	5.5	5.5
Vert. height mm	15	9.5
Order No.	26195	26194

Polymerization Sleeve

Silicone (15), non-sterile

- Single-use
- The polymerization sleeve protects the soft tissue from acrylic resin

Polymerization Sleeve



Order No.	31021405 / 31021890*
-----------	----------------------

Multibase EV Replica

Stainless steel (6), non-sterile

- Single use
- Marked with a groove for identification

Multibase EV Temporary Cylinder

Titanium (2), non-sterile

- Marked with a groove for identification

Multibase EV Burnout Cylinder

PMMA burnout plastic (11), non-sterile

- Marked with a groove for identification

Note: Bridge screws need to be ordered separately.

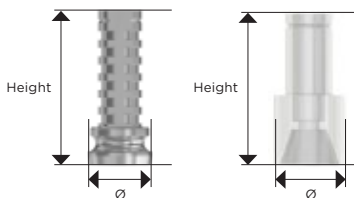

Multibase EV

Replica

Temporary Cylinder

Burnout Cylinder



Ø mm	-	5.0	4.8
Vertical height mm	-	12	10
Order No.	26201	26202	26203

* For US/CA markets

**Multibase EV
Bridge Screw**



**Multibase EV Lab
Bridge Screw**



	M1.4	M1.4
Screw head height mm	1.65	1.65
Screw head Ø mm	2.1	2.1
Order No.	26196	26200*

Multibase EV Bridge Screw Hex

Titanium (2), non-sterile

- Marked with a groove for identification
- M1.4, anodized (light blue)

Multibase EV Lab Bridge Screw

Titanium (2), non-sterile

- Marked with a groove for identification
- *QTY 4

**Multibase EV Lab
Abutment Pin**



Length mm	14	18	22
Order No.	26197	26198	26199

Multibase EV Lab Abutment Pin

Stainless steel (6), non-sterile

- Marked with a groove for identification

SmartFix® Guide



Order No.	26205
-----------	-------

SmartFix® Guide

Stainless steel (6), non-sterile

- Three-piece
- Used for guiding the drilling with correct angulation

Attachment-retained restorations – abutment level

Locator™ Abutment EV

Titanium (2), TiN (8), coated non-sterile

- Locator Core Tool required
-  Index-free abutments will be seated in any rotational position.

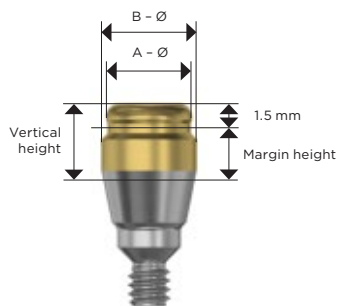

3.6 Locator™ Abutment EV 3.6



A - Ø mm	3.85	3.85	3.85	3.85	3.85
B - Ø mm	3.7	3.7	3.7	3.7	3.7
Height mm	1	2	3	4	5
Order No.	25657	25658	25659	25660	25661

4.2 Locator™ Abutment EV 4.2



A - Ø mm	3.85	3.85	3.85	3.85	3.85
B - Ø mm	3.7	3.7	3.7	3.7	3.7
Height mm	1	2	3	4	5
Order No.	25662*	25663*	25664*	25665*	25666*

4.8 Locator™ Abutment EV 4.8



A - Ø mm	3.85	3.85	3.85	3.85	3.85
B - Ø mm	4.3	4.3	4.3	4.3	4.3
Height mm	1	2	3	4	5
Order No.	25667*	25668*	25669*	25670*	25671*



*Compatible with Astra Tech Implant EV Profile

Locator™ Core Tool

Stainless steel (6), non-sterile
Includes plastic holder/sleeve for manual placement of the abutment.

Locator™ Abutment Pick-up

Aluminum (7), non-sterile
QTY 4

Locator™ Abutment Replica

Aluminum (7), non-sterile

- Single use
QTY 4

Locator™

Abutment Pick-up

Closed tray technique

Abutment Replica

Driver

Core Tool

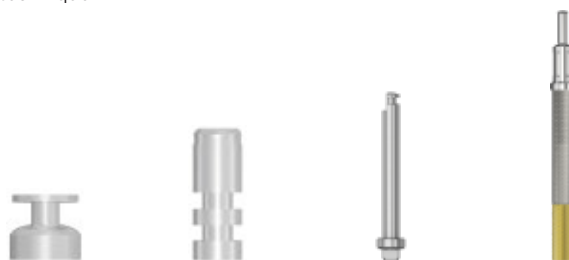

Total length mm			23	
Order No.	24484	24485	25766	24482

Locator™ Process Kit



Order No.	24483
-----------	-------

Locator™ Insert Male

Blue



Pink



Clear



Grams	680	1361	2268
Retention force, kg	0.7	1.4	2.3
Order No.	24488	24487	24486

Locator™ Insert Extended Range Male

Grey



Red



Orange



Green



Grams	0	226-680	907	1361-1814
Retention force, kg	0	0.5	0.9	1.8
Order No.	25679	24492	25843	24489

3.6 Ball Abutment EV 3.6



A/B Ø mm	3.6	3.6	3.6	3.6	3.6	3.6
Height mm	1	2	3	4	5	7
Vert. height mm	3.9	4.9	5.9	6.9	7.9	9.9
Order No.	25684	25685	25686	25687	25688	25689

4.2 Ball Abutment EV 4.2



A/B Ø mm	3.6	3.6	3.6	3.6	3.6	3.6
Height mm	1	2	3	4	5	7
Vert. height mm	3.9	4.9	5.9	6.9	7.9	9.9
Order No.	25690*	25691*	25692*	25693*	25694*	25695*

Locator™ Process Kit

QTY 2 sets

Locator™ Insert - Male

Nylon (16), non-sterile

The clear, pink and blue insert retention parts allow for a divergence of up to 10° for a single implant and 20° between implants. QTY 4

Locator™ Insert - Extended Range Male

Nylon (16), non-sterile

The grey, red, orange and green inserts permit a divergence of 10–20° for a single implant and up to 40° between implants.

The grey insert is used temporary during long-term treatment for protecting the abutments. QTY 4

Ball Abutment EV

Titanium (2), sterile

- Diameter of the ball is 2.25 mm
- Index-free abutments will be seated in any rotational position.

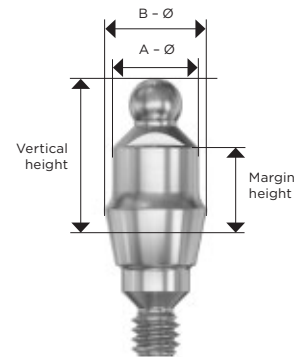

*Compatible with Astra Tech Implant EV Profile



*Compatible with
Astra Tech Implant EV Profile

4.8 Ball Abutment EV 4.8

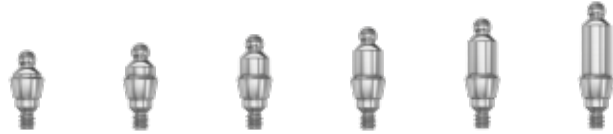

A Ø mm	3.6	3.6	3.6	3.6	3.6	3.6
B Ø mm	4.3	4.3	4.3	4.3	4.3	4.3
Height mm	1	2	3	4	5	7
Vert. height mm	3.9	4.9	5.9	6.9	7.9	9.9
Order No.	25696*	25697*	25698*	25699*	25700*	25701*

Ball Abutment EV Replica

Stainless steel (6), non-sterile

- Single use

Ball Abutment Driver EV

Stainless steel (6), non-sterile

Ball Abutment Driver EV required for installation and removal.

Ball Abutment EV Replica



Order No. 25826

Ball Abutment Driver EV



Total length 22.7
Order No. 25768

Dalbo Plus Female Part Basic includes:

- Dalbo Plus attachment
Titanium (2), non-sterile
- Lamellae retention Insert E
Gold alloy (4), non-sterile
- Dalbo Plus Duplicating Aid
Plastic (12), non-sterile

Dalbo Plus Screwdriver/Activator

Stainless steel (6), non-sterile

Used with Ball Abutment for ball solutions.

Dalbo Plus

Female Part TE Basic, complete



Order No. 25834

Lamellae retention Insert E



25844

Duplicating Aid



25827

Screwdriver/Activator



25835

OD Cylinder EV

Gold alloy (4)

Non-sterile

Used with Uni Abutment EV for bar solution

- Compatible with most bar system on the market

OD Cylinder EV



Order No. 25638

Instruments

A user-friendly tray assortment – adaptable to the clinical preferences

The flexible tray design with interchangeable overlays allows for adaption of tray content according to your clinical preferences. Each overlay has an intuitive layout to support the user during the procedure. The washtrey is intended for automated reprocessing of surgical instruments and ideal for large clinics or hospitals looking for a time- and cost efficient clinical workflow.



Small Tray EV

A flexible, compact and convenient small tray for restorative and surgical procedures and a storage option.

Drills with excellent cutting properties

Multiple-use drills delivered in sterile packaging for the option of single-use. In addition to the diameter, all drills shafts are color-coded and marked with a number/letter for easy identification and reference.



A user-friendly packaging designed for easy handling.*



Versatile torque wrench design

Few parts and designed for easy handling and cleaning procedures. Interchangeable driver handles for versatile surgical and restorative needs.

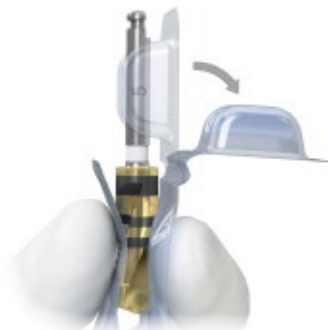

*Patent pending

Trays

One surgical tray - with interchangeable overlay

PPSU plastic (14), silicone (15) holders

- Tray design with interchangeable overlays allows for adaptation of tray content according to your clinical preferences.
- Color-coded and intuitive layout.

Overlay 1

- Accommodates all implant lengths and designs for Astra Tech Implant EV straight and conical implants including Astra Tech Implant EV Profile for the most commonly used implant diameters.



Overlay 2

- Accommodates the complete range of diameters for Astra Tech Implant EV straight and conical implants, including Astra Tech Implant EV Profile, lengths 8-17 mm.

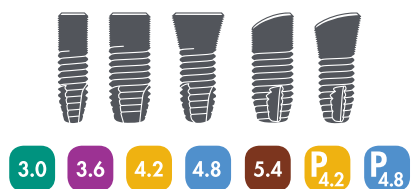

Overlay 3

- Supports the full implant assortment.

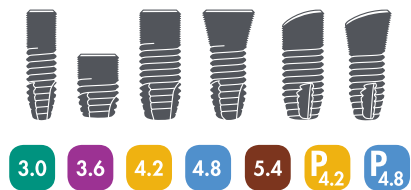

Large Tray EV, shown with Overlay 1



Measurements mm	Length 290	Width 178	Height 54
Order No.	25769		

Overlay 2

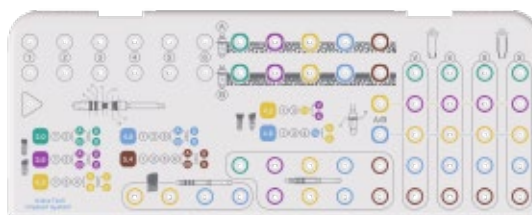

Overlay 3

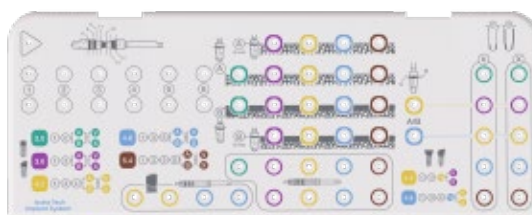

	Overlay 1	Overlay 2	Overlay 3
Order No.	25721	25722	25723



Small Tray EV including overlay Restorative

Order No.	25982*
-----------	--------

Small Tray EV including overlay Surgical

Order No.	25983*
-----------	--------

Small Tray EV including overlay Storage

Order No.	25984*
-----------	--------



Small Tray EV no overlay

Measurements mm	Length	Width	Height
	160	95	46
Order No.	25770		

Overlay Restorative



Overlay Surgical

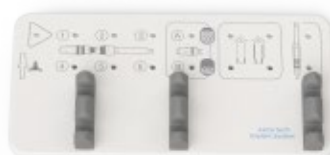

Overlay Storage

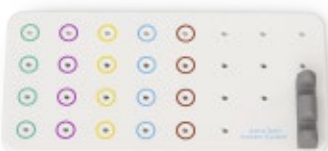

Overlay	Restorative	Surgical	Storage
Order No.	25724*	25725*	25845*

Small Tray EV

PPSU plastic (14) silicone (15) holders

A flexible, compact and convenient small tray for restorative and surgical procedures and a storage option.

Restorative

- Convenient storage of your restorative instruments for an efficient workflow
- One simple overlay supporting all restorative procedures; cement-, screw- or attachment-retained

Surgical

- Highly versatile overlay supporting a procedure-based workflow
- Easily adapted for clinical preferences to ensure only the needed instruments are at hand, preventing unnecessary cleaning
- Ideal for single-tooth procedures

Storage

- Flexible storage options for less frequently used drills and instruments, minimizing unnecessary wear
- Add-on solution or complement to Large Tray EV

Small Tray EV Overlay

PPSU plastic (14) silicone (15) holders

- Tray design with three interchangeable overlays allows for adaptation of tray content according to your clinical preferences

*Instruments not included.

Small Tray EV and Overlay Bone Reamer

PPSU plastic (14) silicone (15) holders



Small Tray EV including overlay Bone Reamers

Measurements mm	Length 160	Width 95	Height 46
Order no.	26218*		

Overlay Bone Reamer

Order no.	26217*
-----------	--------

*Instruments not included.

Bone Reamer EV

Stainless steel (6), non-sterile

- The bone reamers and bone reamer guides are available from 3.0 to 5.4 in the OsseoSpeed EV assortment and cover the use for most abutment diameters and designs.
- Laser-etched depth indication lines
- Marked with diameter
- Used for removing excess crestal bone when needed for proper abutment seating

Bone Reamer EV



Ø mm	4.0	4.6	5.2	5.8	6.4	7.0
Total length mm	26	26	26	26	26	26
Order no.	26206	26207	26208	26209	26210	26211

Bone Reamer Guide EV

Stainless steel (6), non-sterile

- Used to guide the Bone Reamer EV

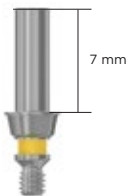

Bone Reamer Guide EV

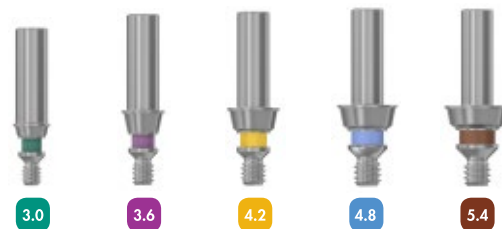

Order no.	26212	26213	26214	26215	26216
-----------	-------	-------	-------	-------	-------

SmartFix® Guide

Stainless steel (6), non-sterile

- Three-piece
- Used for guiding the drilling with correct angulation

SmartFix® Guide



Order No.	26205
-----------	-------

Washtrays

Washtray Astra Tech Implant System EV

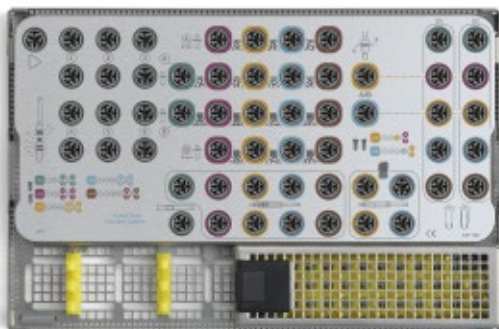

Measurements mm	Length	Width	Height
	275	176	64
Order No.	3107 1000		

Washtray GS Astra Tech Implant System EV

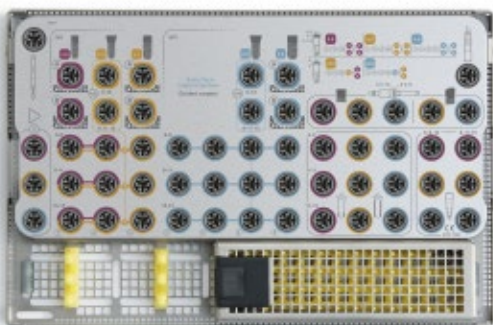

Measurements mm	Length	Width	Height
	275	176	64
Order No.	3107 1020		

Washtray Sterilization Container Astra Tech Implant System EV



Outer dimensions mm	Length	Width	Height
	312	190	92
Inner dimensions mm	280	180	78
Order No.	3107 1002		

Washtray

- One tray for all steps of reprocessing: enhances time- and cost-efficiency
- Instruments are fixed and organized from chair-side through all steps of reprocessing and back to chair-side
- Sterilization container for simple, quick and safe handling can be ordered separately

Note: The overlay must be separated from the washtray before cleaning and re-assembled prior sterilization. Please see "Dentsply Implants Instruction for Sterilization and Instrument Care"!

Washtray Astra Tech Implant System EV

- Including metal tray with instrument holders, overlay and guide
- The removable overlay has a layout very similar to overlay 3 the existing plastic surgical kit

Material

Tray: Stainless steel (6)
 Overlay: Aluminum (7)
 Yellow parts: Silicone (15)
 Holders: PEEK-plastic (10) with metal spring

Spare parts	Order No.
Washtray Overlay Astra Tech Implant System EV, Aluminum	3107 1001
Instrument Holder f ISO shank, PEEK-plastic with metal spring	3107 1004
Instrument Holder f Ratchet In, Silicone	3107 1006

Washtray GS Astra Tech Implant System EV

- Including metal tray with instrument holders, overlay and guide
- The removable overlay has a layout very similar to the Proline overlay on the existing plastic surgical kit

Material

Tray: Stainless steel (6)
 Overlay: Aluminum (7)
 Yellow parts: Silicone (15)
 Holders: PEEK-plastic (10) with metal spring

Spare parts	Order No.
Washtray Overlay GS Astra Tech Implant System EV, Aluminum	3107 1021
Instrument Holder f ISO shank, PEEK-plastic with metal spring	3107 1004
Instrument Holder medium, PEEK-plastic with metal spring	3107 1005
Instrument Holder f Ratchet In, Silicone	3107 1006

Washtray Sterilization Container Astra Tech Implant System EV

- Including two reusable filters, could be used for 1000 cycles.

Material

Container: Aluminum (7)

Spare parts	Order No.
Washtray Ster Cont Filter QTY 2	3107 1003

Initial drills

Stainless steel (6), sterile

- Multiple-use with option for single use except for Precision Drill EV, which is single-use only
- Use for marking and reating a start point

Note: Precision Drill EV is extremely sharp and should never be handled manually once out of its package

Guide Drill EV



Precision Drill EV



Ø mm	n/a	n/a
Order No.	25160	25161

Spongy bone preparation

Stainless steel (6), TiN-coated (8), sterile

Twist Drill: Used for initial preparation and evaluation of the bone

Step Drill: Used for site preparation, resulting in a stepped osteotomy with apical bone support for the implant. The drills 2-6 provide guidance during the drilling process

- Laser-etched depth indication lines
- Multiple-use with option for single use
- Marked with drill diameter and corresponding number/letter
- Drills for spongy bone preparation are color-coded white (1) - (6)



Twist Drill EV, 6-13 mm

①



Ø mm	1.9
Order No.	25163

Step Drill EV, 6-13 mm

②



Ø mm	1.9/2.5
Order No.	25165

③



Ø mm	2.5/3.1
Order No.	25169

④



Ø mm	3.1/3.7
Order No.	25173

⑤



Ø mm	3.7/4.3
Order No.	25177

⑥



Ø mm	4.3/4.9
Order No.	25181

Drilling depth

The drilling depth is measured from the widest part of the drill tip up to the indication line.

Additional tip depth is maximum 1.0 mm regardless of the drill diameter.

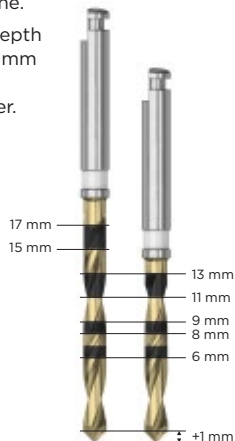

Twist Drill EV, 6-17 mm

①



Ø mm	1.9
Order No.	25162

Step Drill EV, 6-17 mm

②



Ø mm	1.9/2.5
Order No.	25164

③



Ø mm	2.5/3.1
Order No.	25168

④



Ø mm	3.1/3.7
Order No.	25172

⑤



Ø mm	3.7/4.3
Order No.	25176

⑥



Ø mm	4.3/4.9
Order No.	25180

Cortical bone preparation – straight implants

A - Cortical Drill EV

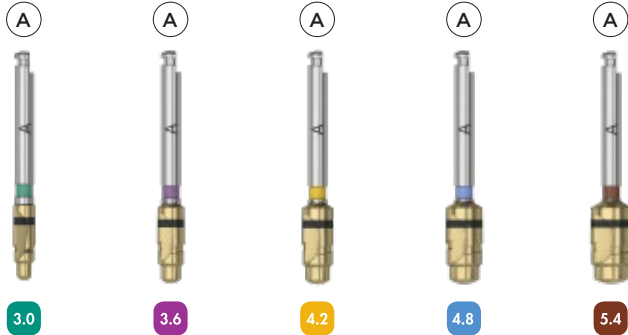

Ø mm	2.5/2.7	3.1/3.3	3.7/3.9	4.3/4.5	4.9/5.1
Order No.	25423	25488	25490	25492	25431

Cortical bone preparation – straight implants

Stainless steel (6), TiN-coated (8), sterile
Mandatory preparation of the cortical layer to reduce pressure in the bone around the implant neck.

- Multiple-use with option for single-use
- Cortical bone preparation drills color-coded according to implant-abutment connection.
- Color: corresponds to implant size
- Markings: diameter and drill letter
- Select (A) - or (B) - Cortical Drill EV according to cortical bone thickness
- (A) - thin cortical bone < 2 mm
- (B) - thick cortical bone ≥ 2 mm
- Length: one option

Note: There are separate cortical drills specific for the 6 mm implant.

B - Cortical Drill EV

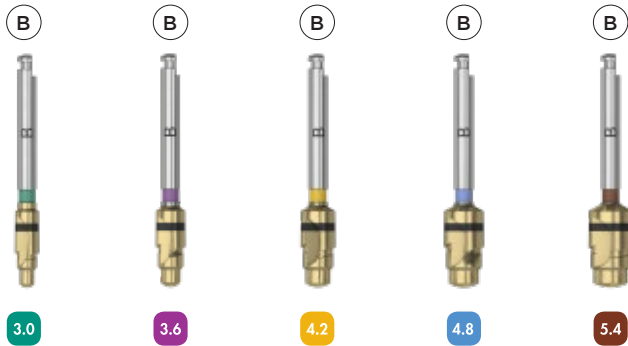

Ø mm	2.5/3.0	3.1/3.6	3.7/4.2	4.3/4.8	4.9/5.4
Order No.	25193	25195	25197	25199	25201

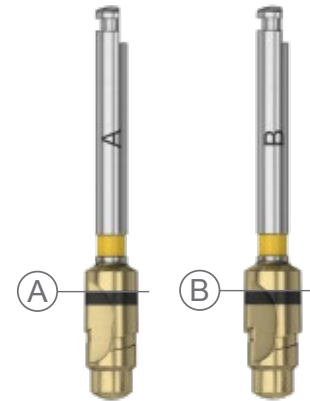

A 6mm - Cortical Drill EV



Ø mm		3.1/3.3	3.7/3.9	4.3/4.5	4.9/5.1
Order No.		25487	25412	25420	25422

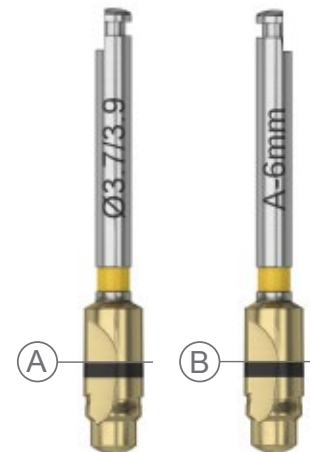

B 6mm - Cortical Drill EV

	3.6	4.2	4.8	5.4
Ø mm	3.1/3.6	3.7/4.2	4.3/4.8	4.9/5.4
Order No.	25411	25419	25421	25424

Cortical bone preparation – conical implants

Cortical bone preparation – conical implants

Stainless steel (6), TiN-coated (8), sterile

Mandatory preparation of the cortical layer to reduce pressure in the bone around the implant neck.

Apical border of the indication line indicates the minimum depth needed to fit the implant.

Select the (A)- or (B)- depth indication according to cortical bone thickness.

(A) In thin cortical bone, drill to the depth indication line as shown in the illustration.

(B) In thick cortical bone, drill to the full depth of the depth indication line as shown in the illustration.

Make sure enough depth is provided for the entire implant.

- Multiple-use with option for single-use
- Color: corresponds to implant
- Markings: diameter and drill letter
- Length: one option

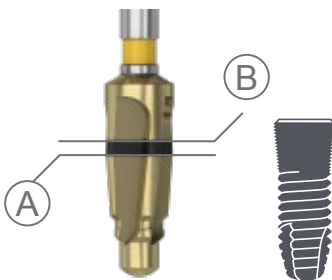

A/B - Conical Drill EV



	4.2	4.8
Ø mm	3.1/4.2	3.7/4.8
Order No.	25188	25190



Spongy bone preparation - in medium or dense bone

V - Twist Drill EV, 6-13 mm

Ø mm	2.5	3.1	3.7	4.3	4.9
Order No.	25985	25986	25987	25988	25989

V - Twist Drill EV, 6-17 mm

Ø mm	2.5	3.1	3.7	4.3	4.9
Order No.	25780	25781	25782	25783	25784

X - Step Drill EV, 6-13 mm

Ø mm	2.5/2.85	3.1/3.45	3.7/4.05	4.3/4.65	4.9/5.25
Order No.	25482	25483	25484	25485	25486

X - Step Drill EV, 6-17 mm

Ø mm	2.5/2.85	3.1/3.45	3.7/4.05	4.3/4.65	4.9/5.25
Order No.	25990	25991	25992	25993	25994

V-Twist Drill - apical preparation

Stainless steel (6), TiN-coated (8), sterile
Following opening of the marginal cortical layer with cortical drill (A), (B) or conical drill (A/B), the (V)-twist drill is used to remove the apical step and creating a straight osteotomy.

The (V)-Twist Drill is strongly advocated in most medium and dense bone situations to remove the apical bone contact and hereby reduce the risk for high installation torque and periapical bone pressure.

- Multiple-use with option for single-use
- Color: corresponds to implant **Note:** for conical implants, this color refers to the implant body diameter.
- Markings: diameter and (V)
- Length: short (6-13 mm)
long (6-17 mm)

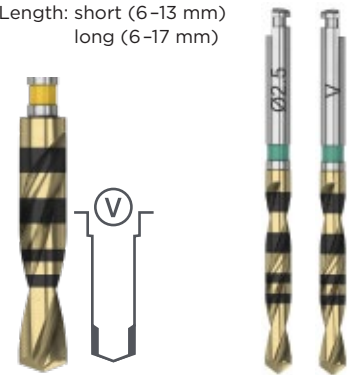

X-Step Drill - body and apical preparation

Stainless steel (6), TiN-coated (8), sterile
Following opening of the marginal cortical layer with cortical drill (B) or conical drill (A/B), to level B, the (X)-step drill is used in dense bone situations to widen the entire osteotomy, i.e. the body portion of the osteotomy and remove the apical bone contact.

- Multiple-use with option for single-use
- Color: corresponds to implant **Note:** for conical implants, this color refers to the implant body diameter.
- Markings: diameter and (X)
- Length: short (6-13 mm)
long (6-17 mm)

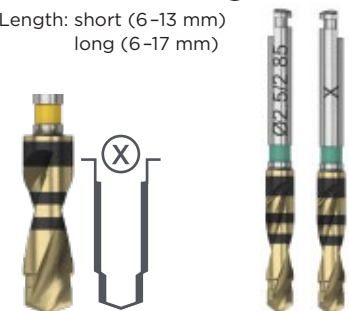

Surgical instruments

Implant Driver EV

Stainless steel (6), non-sterile

- For picking up and installing implant.
- Marked with depth and diameter
- Dimple to facilitate correct positioning

Note: For use with Contra Angle or Torque Wrench EV Surgical Driver Handle

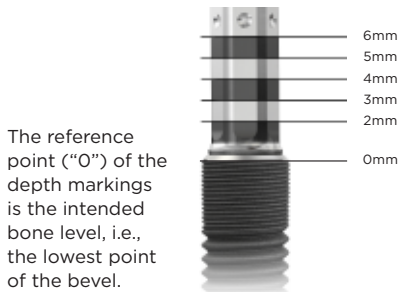

Implant Driver EV Short



3.6 4.2 4.8 5.4

Total length mm	23.5	23.5	24	24
Order No.	25378	25380	25382	25384

Implant Driver EV Long



3.0 3.6 4.2 4.8 5.4

Total length mm	33.5	33.5	34.0	34.0	34.0
Order No.	25377	25379	25381	25383	25385

Direction Indicator EV

Titanium alloy (2), non-sterile

- For use after drill ① and drill ③



Direction Indicator EV

Implant Driver Extender EV-GS

Implant Depth Gauge EV



Order No.	25765	26021	25710
-----------	-------	-------	-------

Implant Driver Extender EV-GS

Stainless steel (6), non-sterile

- Used for extending the length of a drill or the Implant Driver EV or Implant Driver EV-GS.

Note: Implant Driver Extender EV should only be used together with drills, Implant Driver EV or Implant Driver EV-GS.

Implant Depth Gauge EV

Titanium (2), non-sterile

- One side corresponds to implant lengths 6-17 mm
- One side is measuring probe with 0-15 mm markings

Titanium Bowl

Titanium



Order No.	22137
-----------	-------

Forceps

Titanium



Length	94 mm
Order No.	22437

Torque Wrench EV



Order No.	25774	25775
-----------	-------	-------

Torque Wrench EV Surgical Driver Handle



Torque Wrench EV

Stainless steel (6), non-sterile
Use together with Surgical Driver Handle
For implant installation and adjustment of implant position

Torque Wrench EV Surgical Driver Handle

Stainless steel (6), non-sterile

Hex Driver EV Machine

Short



Intermediate



Long



Total length mm	20	24	35
Order No.	25790	25727	25728

Hex Driver EV Machine

Stainless steel (6), non-sterile
For use with Contra Angle or Torque Wrench EV Surgical Driver Handle or Torque Wrench EV Restorative Driver Handle

Hex Driver EV Manual

Short



Intermediate



Long



Total length mm	20	31	38
Order No.	25771	25772	25773

Hex Driver EV Manual

Stainless steel (6), non-sterile

Mucosal Punch EV



Ø	3.5	4	4.5	5	5.5	6.5
Order No.	25711	25712	25713	25714	25715	25731

Mucosal Punch EV

Stainless steel (6), ABS Plastic (17)
Sterile
■ Single use only
QTY 5

Radiographic Implant Guides EV



Order No.	25500
-----------	-------

Bone Trap™



Order No.	22179
-----------	-------

Radiographic Implant Guides EV

Plastic (12), non-sterile
■ Planning tools used prior to implant surgery
■ Used together with x-ray of the patients' jaw
■ Magnification range is from 1.0 to 1.8 presented in 9 separate sheets

Bone Trap™

Plastic (12), sterile
■ Single-use
■ Simplifies the procedure of collecting and using autologous bone
Disposable and delivered sterile
QTY 1

Surgical units

Implant 900 Set

Set includes:

- Control unit
- Motor EM-19
- Foot Control S-N2
- Contra-angle WI-75 E/KM
- Irrigation Set, single-use (3 pcs.)
- Accessories



Implant 900 Set SI-923, 230V

Implant 900 Set SI-915, 120V

Order No.	26264	26265
-----------	-------	-------

Contra-angles

- Suitable for drills with internal and external irrigation
- WS-75 L G provides LED light from an integrated generator (LED > 300 rpm)

Contra-angle
WI-75 E/KM



20:1

Contra-angle
WS-75



20:1

Contra-angle
WS-75 L G



20:1

Order No.	26273	26268	26269
-----------	-------	-------	-------

Handpieces

- Mainly intended for general oral surgery procedures

Contra-angles and handpieces

- Can be disassembled, except WI-75 E/KM
- Compatible with previous motors for Frios Unit S/i and Astra Implant Unit SI
- Thermo washer disinfectable and sterilizable

Handpiece S-11 Straight



1:1

Handpiece S-9 Angled



1:1

Order No.	26270	26271
-----------	-------	-------

Accessories

- Motor - 1.8 m cable with 5 clips
- Foot Control - 2.8 m cable
- Motor and Foot Control are not compatible with previous Frios Unit S/i or Astra Implant Unit SI

Motor EM-19



Foot Control S-N2, with cord



Order No.	26266	26267
-----------	-------	-------

Irrigation tubing and cover

- Complete irrigation set for Implant 900 & 1000, Frios Unit S/i & S and Astra Implant Unit SI (with 1.8 m motor cable); single-use, sterile
- Irrigation tubing extension, connected with Luer Lock; single-use, sterile
- Cover sleeve 240x7 cm, with latex-free elastic bands, for motor and cable; single-use, sterile

Irrigation Set
(10 pcs.)



24785

Tubing Extension
with Luer (10 pcs.)



24786

Tubing Cover Sleeve
(10 pcs.)



24787

Order No.	24785	24786	24787
-----------	-------	-------	-------



Implant 1000 Set SI-1023, 230V

Implant 1000 Set SI-1015, 120V

	w. cord	w. cord
Order No.	26278	26279
	cordless	cordless
Order No.	26281	26282

Contra-angle WS-75 L



20:1

Order No.	26394
-----------	-------

Handpiece S-11 L Straight



1:1

Order No.	26395
-----------	-------

Motor EM-19 LC



Order No.	26392
-----------	-------

Foot Control S-N2, with cord



Order No.	26267
-----------	-------

Foot Control S-NW, cordless



Order No.	26393
-----------	-------

Irrigation Set (10 pcs.)



Order No.	24785
-----------	-------

Tubing Extension with Luer (10 pcs.)



Order No.	24786
-----------	-------

Tubing Cover Sleeve (10 pcs.)



Order No.	24787
-----------	-------

Implant 1000 Set

Set includes:

- Control unit
- Motor EM-19 LC
- Foot Control (options: with cord, S-N2 or cordless, S-NW)
- Contra-angle WS-75 L
- Irrigation Set, single-use (3 pcs.)
- Accessories

Contra-angle

- Suitable for drills with internal and external irrigation
- Extra short contra-angle for improved ergonomics

Handpiece

- Mainly intended for general oral surgery procedures

Contra-angle and handpiece

- WS-75 L and S-11 L provide continuous LED light from electrical contacts in the motor
- Can be disassembled
- Not compatible with previous motors for Frios Unit S/i and Astra Implant Unit SI
- Thermo washer disinfectable and sterilizable

Accessories

- Motor with electrical contacts - 1.8 m cable with 5 clips
- Foot Control with cord - 2.8 m cable and cordless version
- Motor and foot controls are not compatible with previous Frios Unit S/i or Astra Implant Unit SI

Irrigation tubing and cover

- Complete irrigation set for Implant 900 & 1000, Frios Unit S/i & S and Astra Implant Unit SI (with 1.8 m motor cable); single-use, sterile
- Irrigation tubing extension, connected with Luer Lock; single-use, sterile
- Cover sleeve 240x7 cm, with latex-free elastic bands, for motor and cable; single-use, sterile

Restorative instruments

Hex Driver EV Manual
Stainless steel (6), non-sterile

Hex Driver EV Manual

Short

Intermediate

Long



Total length mm	20	31	38
Order No.	25771	25772	25773

Hex Driver EV Machine
Stainless steel (6), non-sterile
For use with Contra Angle or Torque Wrench EV
Surgical Driver Handle or Torque Wrench EV
Restorative Driver Handle

Hex Driver EV Machine

Short

Intermediate

Long



Total length mm	20	24	35
Order No.	25790	25727	25728

Atlantis® Angulated Screw Access Screwdriver

Stainless steel (6), non-sterile

- Must be used in combination with Atlantis implant suprastructures that have been designed and manufactured with Angulated Screw Access on 1 or more connections
- Every connection with angulated screw access is supplied with a corresponding Atlantis prosthetic screw
- Angulated screw access allows the prosthetic screw access channel to be angled up to 30 degrees off the implant/abutment axis, for optimal esthetics and function

Atlantis® Angulated Screw Access Screwdriver



Total length mm	18	24	32
Order No.	36030	36031	36032

Multibase Driver EV



Total length mm	19
Order No.	26204

Multibase Driver EV

Stainless steel (6), non-sterile

- Used for installation and removal of the Multibase EV Abutment
- The Surgical Driver Handle could be useful when removing the abutment to support the torque transferring

**Direct Driver EV
Ø3.3 Ø4**



Uni Driver EV



Locator™ Driver EV



Total length mm	26	21.5	23
Order No.	25764	25708	25766

Direct Driver EV

Stainless steel (6), non-sterile

Required for carrying and installation of Direct Abutment EV Ø3.3 and Ø4

Uni Driver EV

Stainless steel (6), non-sterile

- For installation and removal of Uni Abutment EV

Locator™ Driver EV

Stainless steel (6), non-sterile

For placement and removal of Locator abutments

Ball Abutment Driver EV

Stainless steel (6), non-sterile

For placement and removal of Ball Abutment EV

Direct, Uni, Locator and Ball Abutment drivers fit Torque Wrench EV driver handles.

Dalbo Plus Screwdriver/Activator

Stainless steel (6), non-sterile

Locator™ Core Tool

Stainless steel (6), non-sterile

Includes plastic holder/sleeve for manual placement of the abutment

Ball Abutment Driver EV



Dalbo Plus Screwdriver/Activator



Locator™ Core Tool



Total length mm	22.7		
Order No.	25768	25835	24482

Abutment Depth Gauge EV

Titanium (2), non-sterile

- Laser etched bands for measuring mucosal height over the implant in millimeters.
- Waist at 4-5 mm indication for better visual orientation.

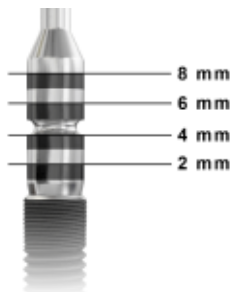

Abutment Depth Gauge EV



Order No.	25792
-----------	-------



Order No.	25793
-----------	-------



Order No.	25726
-----------	-------

Torque Wrench EV

Stainless steel (6), non-sterile

Use together with a restorative driver handle for tightening of abutment and/or bridge screw.

Torque Wrench EV



Order No.	25774
-----------	-------

Torque Wrench EV Restorative Handles

Stainless steel (6), non-sterile

4x4 Low

For compatibility for instruments with a square connection 4 x 4 mm

Torque Wrench EV Restorative Driver Handle

Low

4x4 Low



Order No.	25776	25777	25730
-----------	-------	-------	-------

Laboratory products

Lab Abutment Screw EV



Order No.	25476	25477	25478	25479	25480
-----------	-------	-------	-------	-------	-------

Lab Abutment Screw EV

Titanium (2), anodized, non-sterile
QTY 3

Designed for use with
Implant Replica EV only

Lab Pin Design EV



Ø mm	3.0/3.6	4.2/4.8/5.4
Height mm	25	25
Order No.	25528	25530

Lab Pin Design EV

Stainless steel (6), non-sterile

- For maintenance of screw access channel during the laboratory procedure
- Friction fit to the Lab Abutment Screw EV screw hole

Lab Abutment Pin EV

Short Intermediate Long



Length mm	14	18	22
Order No.	25643	25644	25645

Lab Bridge Screw EV



Screw head height mm	1.6
Screw head Ø mm	2.35
Order No.	25656

Lab Abutment Pin EV

Stainless steel (6), non-sterile

- For maintenance of screw access channel
- Fits the UniAbutment EV Replica

Lab Bridge Screw EV

Titanium (2), non-sterile
QTY 3

Grinding Handle



Order No.	22740
-----------	-------

Polishing Protector Uni EV



Order No.	25778
-----------	-------

Polishing Protector Uni EV

Stainless steel (6), non-sterile
QTY 3



Astra Tech Implant EV Profile

A unique implant specifically designed for sloped ridges

Astra Tech Implant EV Profile is specially shaped for efficient use of existing bone in sloped ridge situations.



One-position-only placement of all indexed components

The unique one-position-only placement makes the entire treatment procedure simple and predictable, from implant placement to the connection of the final abutment.



Wide range of implant options

Available in straight and conical implant designs in 8-17 mm lengths.

Self-guiding impression components for an accurate and predictable workflow

This innovative design provides a time-efficient installation procedure and a predictable workflow between the clinician and dental technician.



Product overview



YELLOW



One-position-only



Index free



Round



Triangular

Implants

Astra Tech Implant EV Profile 4.2 PS



8 mm 26371
9 mm 26372
11 mm 26373
13 mm 26374
15 mm 26375
17 mm 26376

Astra Tech Implant EV Profile 4.2 PC



8 mm 26381
9 mm 26382
11 mm 26383
13 mm 26384
15 mm 26385
17 mm 26386

Cover screw

Cover Screw Profile EV 4.2



0 mm 25582

Healing abutments

HealDesign™ Profile EV 4.2

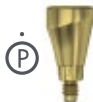

○ Ø 5.0 3 mm 25587
○ Ø 5.0 4 mm 25584
△ Ø 5.0 3 mm 25585
△ Ø 6.5 3 mm 25586

HealDesign EV 4.2



○ Ø 5.0 2.5 mm 25908
○ Ø 5.0 3.5 mm 25501
○ Ø 5.0 4.5 mm 25302
○ Ø 5.0 6.5 mm 25797
○ Ø 6.5 2.5 mm 25909
○ Ø 6.5 3.5 mm 25910
○ Ø 6.5 4.5 mm 25911
○ Ø 6.5 6.5 mm 25912

Healing Uni EV 4.2



○ Ø 4 2 mm 25288
○ Ø 4 3 mm 25579
○ Ø 4 4 mm 25289
○ Ø 4 6 mm 25290

Cement-retained

Temporary abutments

TempDesign™ Profile EV



Ø 7 1 mm 25756

Temp Abutment Profile EV



Ø 4.5 1 mm 26256

Abutments

TiDesign™ Profile EV 4.2



○ Ø 5.5 15° 2 mm 25595
○ Ø 5.5 3 mm 25594
△ Ø 5.5 2 mm 25592
△ Ø 7.0 2 mm 25593

Screw-retained

Abutments

Uni Abutment EV 4.2



1 mm 25562
2 mm 25563
3 mm 25564
5 mm 25565

Angled Abutment Profile EV



1 mm 25890
2 mm 25891

Multibase Abutment EV 4.2



1.5 mm 26170
2.5 mm 26171
3.5 mm 26172
17° 1.5 mm 26177
17° 2.5 mm 26178
30° 1.5 mm 26179
30° 2.5 mm 26180

Healing caps

Uni Abutment EV Heal Cap



Ø 4.3 Short 25952
Ø 4.3 25616
Ø 5.5 Short 25953
Ø 5.5 25617

Angled Abutment EV Heal Cap



25650

Multibase EV Heal Cap



Ø 5.4 - 4 mm 26193

Abutment

Uni Abutment EV Pick-up



Ø 4.3 Short 26245
Ø 4.3 26247
Ø 5.5 Short 26246
Ø 5.5 26248

Uni Abutment EV Transfer



26249

Angled Abutment EV Pick-up



26244

Attachment-retained

Abutments

Locator™ Abutment EV 4.2



1 mm 25662
2 mm 25663
3 mm 25664
4 mm 25665
5 mm 25666

Ball Abutment EV 4.2











1 mm 25690
2 mm 25691
3 mm 25692
4 mm 25693
5 mm 25694
7 mm 25695



















Abutment impressions







Locator™ Abutment Pick-up



24484

<p>Direct Abutment™ EV 4.2</p>  <p> Ø 5 1 mm 25367 Ø 5 2 mm 25368 Ø 5 3 mm 25369 Ø 6 1 mm 25494 Ø 6 2 mm 25495 Ø 6 3 mm 25496 </p> <p>Direct EV API™</p>  <p> Ø 5 25348 Ø 6 25349 </p>	<p>Implant impressions</p> <p>Implant Pick-Up Profile EV</p>  <p>Short 26258 Long 26260</p> <p>Implant Transfer Profile EV</p>  <p>Short 25606 Long 25607</p> <p>Implant Pick-Up Design Profile EV</p>  <p>26262</p>	<p>Lab products</p> <p>Lab Abutment Screw EV</p>  <p>25478 QTY 3</p> <p>Lab Pin Design EV</p>  <p>25530</p> <p>Implant Replica Profile EV</p>  <p>25610</p>
--	---	--

<p>impressions</p> <p>Multibase EV Pick-up</p>  <p>26195</p> <p>Multibase EV Transfer</p>  <p>26194</p>	<p>Lab products</p> <p>Uni Abutment EV Replica</p>  <p>25615</p> <p>Angled Abutment EV Replica</p>  <p>25652</p> <p>Multibase EV Replica</p>  <p>26201</p> <p>Lab Abutment Pin EV</p>  <p>Short 25643 Intermediate 25644 Long 25645</p> <p>Lab Bridge Screw EV</p>  <p>25656 QTY 3</p> <p>Multibase EV Lab Pin</p>  <p>14 mm 26197 18 mm 26198 22 mm 26199</p> <p>Multibase EV Lab Bridge Screw</p>  <p>26200 QTY 4</p>	<p>Cylinders</p> <p>Uni Abutment EV Temporary Cylinder</p>  <p>26250</p> <p>Uni Abutment EV Semi-Burnout Cylinder</p>  <p>25647</p> <p>Uni Abutment EV Burnout Cylinder</p>  <p>25649</p> <p>Angled Abutment EV Temporary Cylinder</p>  <p>25654</p> <p>Angled Abutment EV Semi-Burnout Cylinder</p>  <p>25653</p> <p>Angled Abutment EV Burnout Cylinder</p>  <p>25655</p> <p>Multibase EV Temporary Cylinder</p>  <p>26202</p> <p>Multibase EV Burnout Cylinder</p>  <p>26203</p> <p>Bridge screws</p> <p>Bridge Screw EV</p>  <p>25481</p> <p>Multibase EV Bridge Screw</p>  <p>26196</p>
---	--	---

<p>Replicas</p> <p>Locator™ Abutment Replica</p>  <p>24485</p> <p>Ball Abutment EV Replica</p>  <p>25826</p>	<p>Attachment components</p> <p>Dalbo Plus Female Part TE Basic, complete</p>  <p>25834</p> <p>Locator™ Process Kit</p>  <p>24483</p> <p>Locator™ Insert - Male</p>  <p>Blue 24488 Pink 24487 Clear 24486</p> <p>Locator™ Insert - Extended Range Male</p>  <p>Grey 25679 Red 24492 Orange 25843 Green 24489</p> <p>OD Cylinder EV</p>  <p>25638</p>
---	---

OSSEOSPEED PROFILE EV

Note: Atlantis patient-specific prosthetic solutions are available. Speak with your local Dentsply Sirona Implants representative for more information.

Product overview



BLUE



One-position-only



Index free



Round



Triangular

Implants

Astra Tech Implant EV Profile 4.8 PS



8 mm 26401
9 mm 26402
11 mm 26403
13 mm 26404
15 mm 26405
17 mm 26406

Astra Tech Implant EV Profile 4.8 PC



8 mm 26411
9 mm 26412
11 mm 26413
13 mm 26414
15 mm 26415
17 mm 26416

Cover screw

Cover Screw Profile EV 4.8



0 mm 25583

Healing abutments

HealDesign™ Profile EV 4.8



○ Ø 5 3 mm 25591
○ Ø 6.5 4 mm 25589
△ Ø 5 3 mm 25588
△ Ø 6.5 3 mm 25590

HealDesign™ EV 4.8



○ Ø 5.0 2.5 mm 25913
○ Ø 5.0 3.5 mm 25502
○ Ø 5.0 4.5 mm 25914
○ Ø 5.0 6.5 mm 25915
○ Ø 6.5 2.5 mm 25916
○ Ø 6.5 3.5 mm 25917
○ Ø 6.5 4.5 mm 25306
○ Ø 6.5 6.5 mm 25798
○ Ø 7.5 3.5 mm 25918
○ Ø 7.5 4.5 mm 25919

Healing Uni EV 4.8



○ Ø 4 2 mm 26219
○ Ø 4 3 mm 26220
○ Ø 4 4 mm 26221
○ Ø 4 6 mm 26222

Cement-retained

Temporary abutments

TempDesign™ Profile EV



Ø 8 1 mm 25757

Temp Abutment Profile EV



Ø 5 1 mm 26257

Abutments

TiDesign™ Profile EV 4.8



○ Ø 5.5 15° 2 mm 25599
○ Ø 7.0 3 mm 25598
△ Ø 5.5 2 mm 25596
△ Ø 7.0 2 mm 25597

Screw-retained

Abutments

Uni Abutment EV 4.8



1 mm 25566
2 mm 25567
3 mm 25568
5 mm 25569

Angled Abutment Profile EV



1 mm 25892
2 mm 25893

Multibase Abutment EV 4.8



1.5 mm 26181
2.5 mm 26182
3.5 mm 26183
17° 1.5 mm 26188
17° 2.5 mm 26189
30° 1.5 mm 26190
30° 2.5 mm 26191

Healing caps

Uni Abutment EV Heal Cap



Ø 4.3 Short 25952
Ø 4.3 25616
Ø 5.5 Short 25953
Ø 5.5 25617

Angled Abutment EV Heal Cap



25650

Multibase EV Heal Cap



Ø 5.4 - 4 mm 26193

Abutment

Uni Abutment EV Pick-up



Ø 4.3 Short 26245
Ø 4.3 26247
Ø 5.5 Short 26246
Ø 5.5 26248

Uni Abutment EV Transfer



26249

Angled Abutment EV Pick-up



26244

Attachment-retained

Abutments

Locator™ Abutment EV 4.8



1 mm 25667
2 mm 25668
3 mm 25669
4 mm 25670
5 mm 25671

Ball Abutment EV 4.8











1 mm 25696
2 mm 25697
3 mm 25698
4 mm 25699
5 mm 25700
7 mm 25701

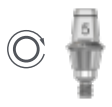

















Abutment impressions







Locator™ Abutment Pick-up



24484

<p>Direct Abutment™ EV 4.8</p>  <p> Ø 5 1 mm 25370 Ø 5 2 mm 25371 Ø 5 3 mm 25372 Ø 6 1 mm 25497 Ø 6 2 mm 25498 Ø 6 3 mm 25499 </p> <p>Direct EV API™</p>  <p> Ø 5 25348 Ø 6 25349 </p>	<p align="center">Implant impressions</p> <p>Implant Pick-Up Profile EV</p>  <p>Short 26259 Long 26261</p> <p>Implant Transfer Profile EV</p>  <p>Short 25608 Long 25609</p> <p>Implant Pick-Up Design Profile EV</p>  <p>26263</p>	<p align="center">Lab products</p> <p>Lab Abutment Screw EV</p>  <p>25479 QTY 3</p> <p>Lab Pin Design EV</p>  <p>25530</p> <p>Implant Replica Profile EV</p>  <p>25611</p>
--	--	---

<p align="center">impressions</p> <p>Multibase EV Pick-up</p>  <p>26195</p> <p>Multibase EV Transfer</p>  <p>26194</p>	<p align="center">Lab products</p> <p>Uni Abutment EV Replica</p>  <p>25615</p> <p>Angled Abutment EV Replica</p>  <p>25652</p> <p>Multibase EV Replica</p>  <p>26201</p> <p>Lab Abutment Pin EV</p>  <p>Short 25643 Intermediate 25644 Long 25645</p> <p>Lab Bridge Screw EV</p>  <p>25656 QTY 3</p> <p>Multibase EV Lab Pin</p>  <p>14 mm 26197 18 mm 26198 22 mm 26199</p>	<p align="center">Cylinders</p> <p>Uni Abutment EV Temporary Cylinder</p>  <p>26250</p> <p>Uni Abutment EV Semi-Burnout Cylinder</p>  <p>25647</p> <p>Uni Abutment EV Burnout Cylinder</p>  <p>25649</p> <p>Angled Abutment EV Temporary Cylinder</p>  <p>25654</p> <p>Angled Abutment EV Semi-Burnout Cylinder</p>  <p>25653</p> <p>Angled Abutment EV Burnout Cylinder</p>  <p>25655</p> <p>Multibase EV Temporary Cylinder</p>  <p>26202</p> <p>Multibase EV Burnout Cylinder</p>  <p>26203</p> <p align="center">Bridge screws</p> <p>Bridge Screw EV</p>  <p>25481</p> <p>Multibase EV Bridge Screw</p>  <p>26196</p>
--	--	---

<p align="center">Replicas</p> <p>Locator™ Abutment Replica</p>  <p>24485</p> <p>Ball Abutment EV Replica</p>  <p>25826</p>	<p align="center">Attachment components</p> <p>Dalbo Plus Female Part TE Basic, complete</p>  <p>25834</p> <p>Locator™ Process Kit</p>  <p>24483</p> <p>Locator™ Insert - Male</p>  <p>Blue 24488 Pink 24487 Clear 24486</p> <p>Locator™ Insert - Extended Range Male</p>  <p>Grey 25679 Red 24492 Orange 25843 Green 24489</p> <p>OD Cylinder EV</p>  <p>25638</p>
--	--

OSSEOSPEED PROFILE EV

Note: Atlantis patient-specific prosthetic solutions are available. Speak with your local Dentsply Sirona Implants representative for more information.

Implants

Astra Tech Implant EV Profile

Titanium (1), sterile

Astra Tech Implant EV Profile implants are available in a range of shapes, diameters and lengths.

PS = Profile Straight PC = Profile Conical



Specific colors have been assigned to the different implant-abutment connection sizes, which are consistently used throughout the system.

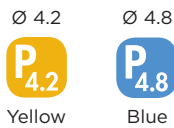

- For further details – see Instructions for Use or the Surgical manual for Astra Tech Implant System EV.
- All implants are made of commercially pure titanium, grade 4.
- OsseoSpeed surface treatment over the entire implant to the top of the first micro threads.
- For conical implants the body portion is 0.6 mm narrower.

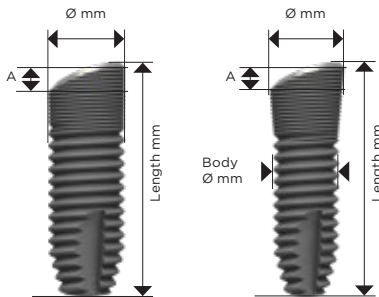

P_{4.2} Astra Tech Implant EV Profile 4.2 PS



Length mm	8	9	11	13	15	17
A - height mm	1.4	1.4	1.4	1.4	1.4	1.4
Order No.	26371	26372	26373	26374	26375	26376

P_{4.2} Astra Tech Implant EV Profile 4.2 PC



Body Ø mm	3.6	3.6	3.6	3.6	3.6	3.6
Length mm	8	9	11	13	15	17
A - height mm	1.3	1.3	1.3	1.3	1.3	1.3
Order No.	26381	26382	26383	26384	26385	26386

P_{4.8} Astra Tech Implant EV Profile 4.8 PS



Length mm	8	9	11	13	15	17
A - height mm	1.7	1.7	1.7	1.7	1.7	1.7
Order No.	26401	26402	26403	26404	26405	26406

P_{4.8} Astra Tech Implant EV Profile 4.8 PC



Body Ø mm	4.2	4.2	4.2	4.2	4.2	4.2
Length mm	8	9	11	13	15	17
A - height mm	1.6	1.6	1.6	1.6	1.6	1.6
Order No.	26411	26412	26413	26414	26415	26416

Cover Screw Profile EV



P
4.2



P
4.8

Order No.	25582	25583
-----------	-------	-------

Radiographic Implant Guides Profile EV



Order No.	25637
-----------	-------

Cover Screw Profile EV

Titanium (2), sterile



- Self-guiding component; engages into the implant only when correctly seated
- One height option for each implant-abutment connection size
- Cover Screw Profile EV is a two-piece cover screw with color coded sleeve. The included screw is without color
- **P** One-position-only cover screw, will seat in one position only

Radiographic Implant Guides Profile EV

Plastic (12), non-sterile

- Planning tools used prior to implant surgery
- Used together with x-ray of the patients' jaw
- Magnification range is from 1.0 to 1.8 presented in 9 separate sheets

Surgical instruments

Implant Driver Profile EV Short



P
4.2



P
4.8

Total length mm	24	24
Order No.	25464	25466

Implant Driver Profile EV Long



P
4.2



P
4.8

Total length mm	34	34
Order No.	25465	25467

Implant Driver Profile EV

Stainless steel (6), non-sterile

- For picking up and installing implant
- Marked with diameter and a "P" for Profile
- Dimple and flat surface on the driver to facilitate correct positioning
- **P** One-position-only instrument, will seat in one position only

NOTE: For use with Contra Angle or Torque Wrench EV Surgical Driver Handle

Healing abutments

HealDesign™ Profile EV

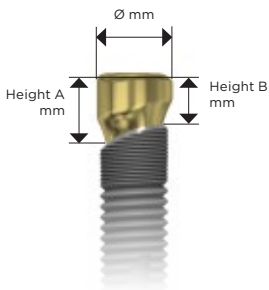

Titanium (2), sterile

- For soft tissue sculpturing during the healing phase
- Self-guiding component; engages into the implant only when correctly seated
- Can be used for both one- and two-stage surgery
- Design is primarily matched to TiDesign Profile EV abutments
- HealDesign Profile EV is a two-piece abutment
- Heights and diameters are harmonized with the permanent abutments as well as with the tooth position
- Round shapes are indicated for all positions in the mouth
- △ Triangular shapes are designed for anterior implant sites and mimic the specific shape for incisors and canines
- Marked with diameter, height and "P" for Profile
- (P) One-position-only, healing abutment, will seat in one position only







NOTE: One-piece healing abutments from the standard assortment can also be used

P_{4.2} HealDesign™ Profile EV 4.2

				
Ø mm	5	5	5	6.5
Height A mm	5	4	4.5	4
Height B mm	4	3	3	3
Order No.	25584	25587	25585	25586

P_{4.8} HealDesign™ Profile EV 4.8

				
Ø mm	5	6.5	5	6.5
Height A mm	4.5	5.5	4.5	4.5
Height B mm	3	4	3	3
Order No.	25591	25589	25588	25590

Temporary abutments

TempDesign™ Profile EV



Ø mm		7	8
Height	bucc A mm	1	1
	ling B mm	1	1
Vertical height mm		12	12
Order No.		25756	25757

TempDesign™ Profile EV

Titanium (2)-PEEK plastic (10), non-sterile, delivered with an abutment screw

- Anatomically pre-designed for reduction technique
- For both screw- and cement-retained restorations
- Can be processed at the laboratory or chairside
- Temporary use; max 180 days
- Screw-retained restorations; limited to single-tooth only
- **(P)** One-position-only abutments, will seat in one position only

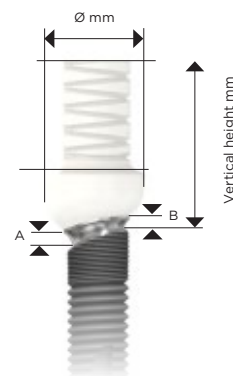

Temp Abutment Profile EV



Ø mm		4.5	5.0
Height	bucc A mm	1	1
	ling B mm	1	1
Vertical height mm		9	9
Order No.		26256	26257

Temp Abutment Profile EV

Titanium (2), non-sterile, delivered with an abutment screw

- Designed for build-up technique
- For large, multi-unit restorations and/or long-term temporization
- Primarily processed in the laboratory
- Cement-retained restorations, all positions in the mouth
- Screw-retained restorations, limited to single-tooth only
- **(P)** One-position-only abutments, will seat in one-position-only

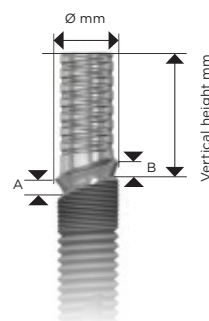

NOTE: A corresponding Abutment Screw EV is included with every temporary abutment as well as final two-piece abutments. To order additional screws, see below

Abutment Screw EV



		M1.8	M2.0
Order No.		25205	25206

Abutment Screw EV

Titanium (2), non-sterile

NOTE: A corresponding Abutment Screw EV is included with every temporary abutment as well as final two-piece abutments.

Cement-retained restorations

TiDesign™ Profile EV

Titanium (2), non-sterile, delivered with an abutment screw

- Round – design for the majority of restorative situations
- △ Triangular – primarily for incisors and canines with triangular shape
- Angled design for offset situations compensating for implants in a restoratively unfavorable position
- Marked with diameter and P for Profile
- Ⓟ One-position-only abutments, will seat in one position only

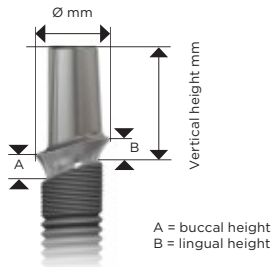

P_{4.2} TiDesign™ Profile EV 4.2

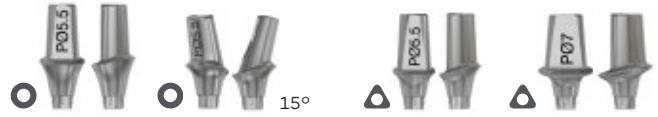

Ø mm	5.5	5.5	5.5	7.0
A - height bucc mm	3	2	2	2
B - height ling mm	3	2	2	2
Vertical height mm	9.5	8.5	8.5	8.5
Order No.	25594	25595	25592	25593

P_{4.8} TiDesign™ Profile EV 4.8



Ø mm	7.0	5.5	5.5	7.0
A - height bucc mm	3	2	2	2
B - height ling mm	3	2	2	2
Vertical height mm	9	8	8	8
Order No.	25598	25599	25596	25597

Screw-retained restorations

Uni Abutment EV (for more information see Product catalog EV)

Titanium (2), sterile

- Supporting multiple unit restorations only
- Design facilitates non-parallel implant situations up to 66°
- Same top cone for all platforms
- Ⓞ Index-free abutments will be seated in any rotational position

Angled Abutment Profile EV

Titanium (2), sterile, delivered with an abutment screw

- Supporting multiple unit restorations only in combination with Uni Abutment EV
- Same top cone as for the standard Angled Abutment EV
- Index-free abutments will be seated in any rotational position
- Marked with a “P”

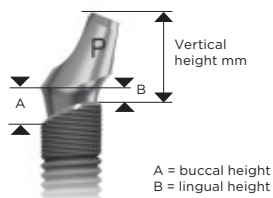

P_{4.2} Angled Abutment Profile EV 4.2, 20°



A - height bucc mm	2	3
B - height ling mm	1	2
Vertical height mm	6	7
Order No.	25890	25891

P_{4.8} Angled Abutment Profile EV 4.8, 20°



A - height bucc mm	2	3
B - height ling mm	1	2
Vertical height mm	6	7
Order No.	25892	25893

Impression and laboratory components

Implant Pick-Up Profile EV, Short

open tray technique

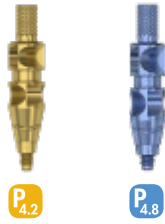

Sleeve Ø mm	4.6	4.6
Height mm	16.5	16.5
Order No.	26258	26259

Implant Pick-Up Profile EV, Long

open tray technique



Sleeve Ø mm	4.6	4.6
Height mm	22	22
Order No.	26260	26261

Implant Pick-Up Profile EV / Implant Pick-Up Design Profile EV

Titanium (2), non-sterile

- Self-guiding positioning
- Marked with a "P"
- Designed with hex at the pin head
- Possibilities of capture the exact soft tissue shape for best possible esthetic results
- Supports indexing options; one-position-only and index free
- Designed for splinting possibilities

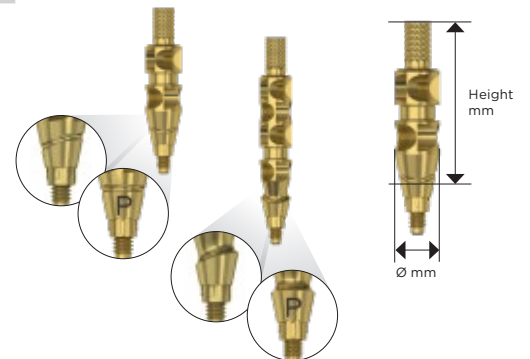

Marked with a sloped groove and a "P" to identify Profile

Implant Pick-Up Design Profile EV

open tray technique



Sleeve Ø mm	4.2	4.8
Height mm	22	22
Order No.	26262	26263

Implant Transfer Profile EV, Short

closed tray technique



Sleeve Ø mm	4.2	4.8
Height mm	11	11
Order No.	25606	25608

Implant Transfer Profile EV, Long

closed tray technique



Sleeve Ø mm	4.2	4.8
Height mm	14	14
Order No.	25607	25609

Implant Transfer Profile EV

Titanium (2), non-sterile

- Self-guiding positioning
- Marked with a "P"
- Must be repositioned in the unique site in the impression
- Designed with a hex at the pin head
- Supports indexing options; one-position-only and index free

Marked with a sloped groove and a "P" to identify Profile



Implant Replica Profile EV



Height mm	16.5	16.5
Order No.	25610	25611

Lab Abutment Screw EV

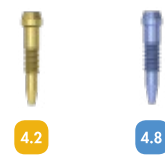

Order No.	25478	25479
-----------	-------	-------

Implant Replica Profile EV

Titanium (2), non-sterile

Adjustment of apex allow for removal of replica from master model without need for sectioning.

- Single use

Lab Abutment Screw EV

Titanium (2), non-sterile

QTY 3

Designed for use with Implant Replica Profile EV and Implant Replica EV only.

Guided surgery with Astra Tech Implant System[®] EV

The combination of Simplant computer-guided implant treatment and the Astra Tech Implant System EV simplifies the process of digital implant dentistry without sacrificing precision and safety.

Sleeve-on-Drill instruments for an easy and safe surgical handling

The sleeve-on design simplifies handling and eliminates the need for additional assistance in holding freestanding drill keys in place.

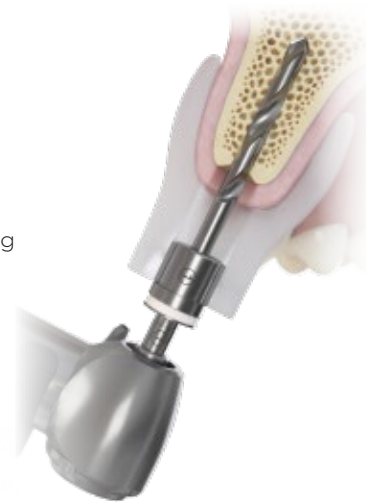

Simplant Safe Guide with lateral opening for easier access

The optional lateral access provides greater ease of handling even for cases with limited inter-occlusal space. This allows for treatment of an expanded range of indications and increased patient comfort and satisfaction.



A user-friendly tray assortment - adaptable to the clinical preferences

The flexible tray design with interchangeable overlays allows for adaption of tray content according to your clinical preferences. Each overlay has an intuitive layout to support the user during the procedure.

The washtray is intended for automated reprocessing of surgical instruments and ideal for large clinics or hospitals looking for a time- and cost efficient clinical workflow.



Trays for guided surgery

One plastic surgical tray with interchangeable overlay

The guided surgical tray design with interchangeable overlays allows for adaptation of tray content according to your clinical preferences.

One surgical tray - with interchangeable overlay

- Color-coded and intuitive layout.
- PPSU plastic (14), silicone (15) holders, non-sterile

Streamline

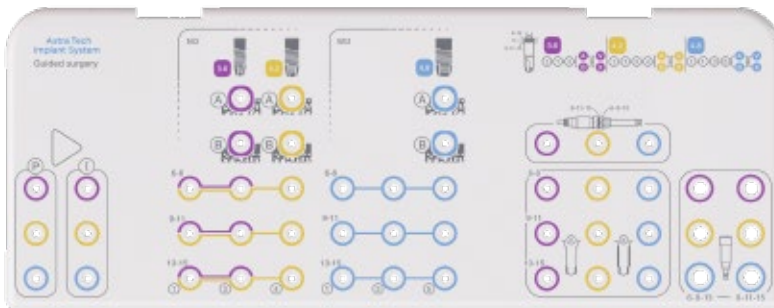

Proline

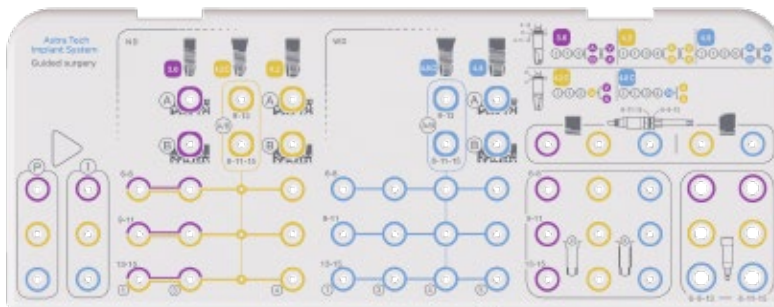

Streamline Base Kit

Streamline

The Streamline Overlay supports the Astra Tech Implant EV straight implants (3.6, 4.2, 4.8) from 6 mm to 15 mm.

Proline

The Proline Overlay supports the complete assortment within guided surgery of Astra Tech Implant EV implants (3.6, 4.2, 4.8) including straight (6 -15 mm), conical (8-15 mm) and Profile EV (8-15 mm).

The overlays can be snapped onto the tray base. This solution offers the possibility of adapting the tray's contents according to individual preferences.

Large Tray EV Streamline Proline
(without overlay)

Order No.	25769	26099	26098
-----------	-------	-------	-------

Astra Tech Implant EV									
	Straight			Conical		Profile Straight		Profile Conical	
Ø	3.6 S	4.2 S	4.8 S	4.2 C	4.8 C	P 4.2	P 4.8	P 4.2	P 4.8
Length									
6 mm	+	+	+						
8 mm	+	+	+	+	+	+	+	+	+
9 mm	+	+	+	+	+	+	+	+	+
11 mm	+	+	+	+	+	+	+	+	+
13 mm	+	+	+	+	+	+	+	+	+
15 mm	+	+	+	+	+	+	+	+	+

**Washtray GS
Astra Tech Implant System® EV**

The Washtray allows for machine cleaning, disinfection and subsequent steam sterilization of instruments. For more information see page 36.

Washtray GS Astra Tech Implant System EV

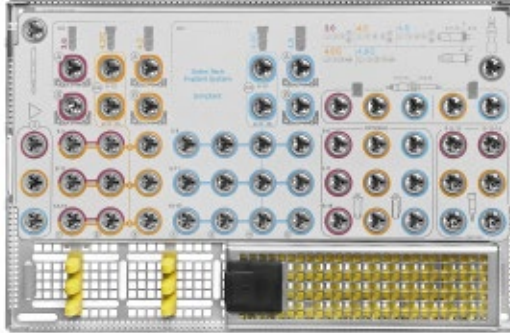

Order No.	3107 1020
-----------	-----------

Spare parts	Order No.
Washtray Overlay GS Astra Tech Implant System EV, Aluminum (7)	3107 1021
Instrument Holder f ISO shank, PEEK-plastic (10) with metal spring	3107 1004
Instrument Holder medium, PEEK-plastic (10) with metal spring	3107 1005
Instrument Holder f Ratchet In, Silicone (15)	3107 1006

Punch/Initial Drill

Punch EV-GS



Ø mm	3.6	4.2	4.8
Order No.	26010	26011	26012

Punch EV-GS

Stainless steel (6), sterile

- Single-use
- Intended for gingivectomy by flapless surgery
- Laser depth indicator according to implant length
- Laser marked with (P), single use (X) and corresponding implant diameter.
- Color: corresponds to implant

Note: By using Simplant software or mySimplant planning service, these Drills can be ordered case specific with the SAFE Guide.

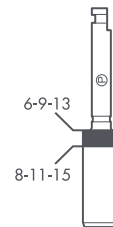

Initial Drill



Ø mm	3.6	4.2	4.8
Order No.	26013	26014	26015

Initial Drill

Stainless steel (6), sterile

- Multiple-use
- Creating a starting point for the following drills
- Laser depth indicator according to implant length
- Laser marked with (I) and corresponding implant diameter.
- Color: corresponds to implant

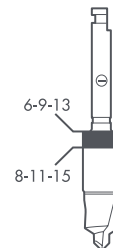

Spongy bone preparation

Drill EV-GS with narrow diameter Sleeve (ND)

Stainless steel (6), sterile

- Drill: Multiple-use
- Sleeve: Single-use
- Drills for spongy bone preparation
- Physical depth stop
- Delivered with Sleeve on Drill
- Laser marked with the corresponding number and drill diameter
- Drills color white for all diameters

Note: By using Simplant software or mySimplant planning service, these Drills can be ordered case specific with the SAFE Guide.

Drill EV-GS with narrow diameter Sleeve (ND)

1-Drill EV-GS, ND



3.6 4.2

3-Drill EV-GS, ND



3.6 4.2

4-Drill EV-GS, ND



4.2

Ø mm	Ø1.9 ND	Ø2.5/3.1 ND	Ø3.1/3.7 ND
Implant length	6–8 mm	6–8 mm	6–8 mm
Order No.	26051	26054	26057
Implant length	9–11 mm	9–11 mm	9–11 mm
Order No.	26052	26055	26058
Implant length	13–15 mm	13–15 mm	13–15 mm
Order No.	26053	26056	26059

Drill EV-GS with wide diameter Sleeve (WD)

Stainless steel (6), sterile

- Drill: Multiple-use
- Sleeve: Single-use
- Drills for spongy bone preparation
- Physical depth stop
- Delivered with Sleeve on Drill
- Laser marked with the corresponding number and drill diameter
- Drills color white for all diameters

Note: By using Simplant software or mySimplant planning service, these Drills can be ordered case specific with the SAFE Guide.

Drill EV-GS with wide diameter Sleeve (WD)

1-Drill EV-GS, WD



4.8

3-Drill EV-GS, WD



4.8

4-Drill EV-GS, WD



4.8

5-Drill EV-GS, WD



4.8

Ø mm	Ø1.9 WD	Ø2.5/3.1 WD	Ø3.1/3.7 WD	Ø3.7/4.3 WD
Implant length	6–8 mm	6–8 mm	6–8 mm	6–8 mm
Order No.	26060	26063	26066	26069
Implant length	9–11 mm	9–11 mm	9–11 mm	9–11 mm
Order No.	26061	26064	26067	26070
Implant length	13–15 mm	13–15 mm	13–15 mm	13–15 mm
Order No.	26062	26065	26068	26071

Cortical bone preparation- straight implants

Cortical Drill EV-GS

(A)-Cortical Drill EV-GS (B)-Cortical Drill EV-GS (A)-Cortical Drill EV-GS (B)-Cortical Drill EV-GS (A)-Cortical Drill EV-GS (B)-Cortical Drill EV-GS



Ø mm	Ø3.1/3.3	Ø3.1/3.6	Ø3.7/3.9	Ø3.7/4.2	Ø4.3/4.5	Ø4.3/4.8
Order No.	26004	26005	26006	26007	26008	26009

Cortical Drill EV-GS

Stainless steel (6), sterile

- Multiple-use
- For straight implants
- Mandatory preparation of the cortical layer to reduce pressure in the bone around the implant neck. The cortical drills are guided directly by the guide sleeve.
- Laser marked with (A) or (B), the drill diameter and implant length
- Laser etched depth indicator
- Select (A) - or (B) - Cortical Drill EV-GS according to cortical bone thickness
- (A) - thin cortical bone < 2 mm
- (B) - thick cortical bone ≥ 2 mm
- Color: corresponds to implant
- Multiple use drill

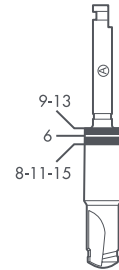

Cortical bone preparation - conical implants

Conical Drill EV-GS

A/B-Drill EV-GS 4.2C, 9-13 A/B-Drill EV-GS 4.2C, 8-11-15 A/B-Drill EV-GS 4.8C, 9-13 A/B-Drill EV-GS 4.8C, 8-11-15



Ø mm	Ø3.1/4.2	Ø3.1/4.2	Ø3.7/4.8	Ø3.7/4.8
Order No.	26000	26001	26002	26003

Conical Drill EV-GS

Stainless steel (6), sterile

- Multiple-use
- For conical implants
- Mandatory preparation of the cortical layer to reduce pressure in the bone around the implant neck. The cortical drills are guided directly by the guide sleeve.
- Select the A- or B depth indication according to the cortical bone thickness
- (A) - thin cortical bone < 2 mm
- (B) - thick cortical bone ≥ 2 mm
- Color: corresponds to implant
- Laser marked with (A/B), the drill diameter and implant length.

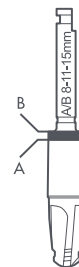

Spongy bone preparation – in medium or dense bone

Spongy bone preparation

V-Drill EV-GS – apical preparation

Stainless steel (6), sterile

- Drill: Multiple-use
- Sleeve: Single-use

Following opening of the marginal cortical layer with cortical drill (A), (B) or conical drill (A/B), the (V)-twist drill is used to remove the apical step and creating a straight osteotomy.

The (V)-Twist Drill is strongly advocated in most situations to remove the apical bone contact and hereby reduce the risk for high installation torque and periapical bone pressure.

- Physical depth stop
- Delivered with Sleeve on Drill
- Laser marked with (V), the drill diameter and implant length
- Color: corresponds to implant
Note: for conical implants, this color refers to the implant body diameter.

Note: By using Simplant software or mySimplant planning service, these Drills can be ordered case specific with the SAFE Guide.

(V)-Drill EV-GS

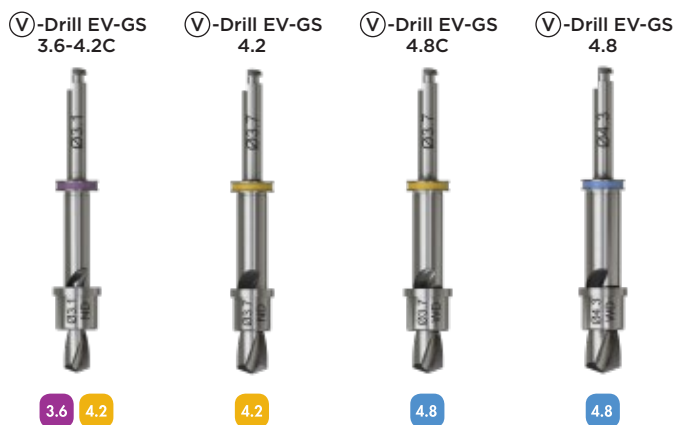

Ø mm	Ø3.1	Ø3.7	Ø3.7	Ø4.3
Implant length	6-8 mm	6-8 mm	6-8 mm	6-8 mm
Order No.	26084	26087	26090	26093
Implant length	9-11 mm	9-11 mm	9-11 mm	9-11 mm
Order No.	26085	26088	26091	26094
Implant length	13-15 mm	13-15 mm	13-15 mm	13-15 mm
Order No.	26086	26089	26092	26095

X-Drill EV-GS – body and apical preparation

Stainless steel (6), sterile

Following opening of the marginal cortical layer with cortical drill (B) or conical drill (A/B) to level B, the (X)-step drill is used in dense bone situations to widen the entire osteotomy, i.e. the body portion of the osteotomy and remove the apical bone contact.

- Drill: Multiple-use
- Sleeve: Single-use
- Physical depth stop
- Delivered with Sleeve on Drill
- Laser marked with (X), the drill diameter and implant length
- Color: corresponds to implant
Note: for conical implants, this color refers to the implant body diameter.

Note: By using Simplant software or mySimplant planning service, these Drills can be ordered case specific with the SAFE Guide.

(X)-Drill EV-GS

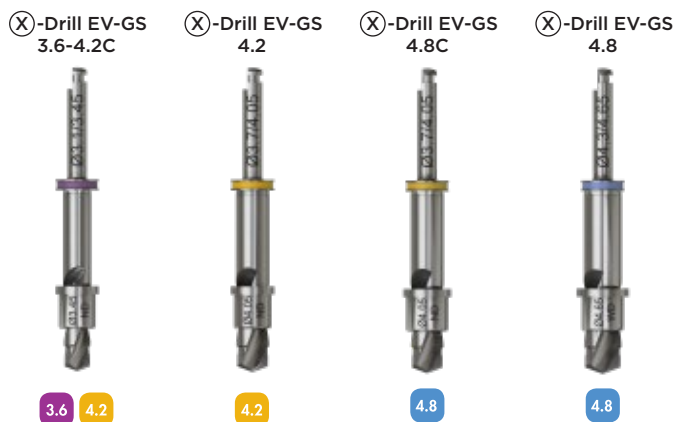

Ø mm	Ø3.1/3.45	Ø3.7/4.05	Ø3.7/4.05	Ø4.3/4.65
Implant length	6-8 mm	6-8 mm	6-8 mm	6-8 mm
Order No.	26072	26075	26078	26081
Implant length	9-11 mm	9-11 mm	9-11 mm	9-11 mm
Order No.	26073	26076	26079	26082
Implant length	13-15 mm	13-15 mm	13-15 mm	13-15 mm
Order No.	26074	26077	26080	26083

Implant Driver EV-GS

Implant Driver EV-GS Implant Driver Profile EV-GS

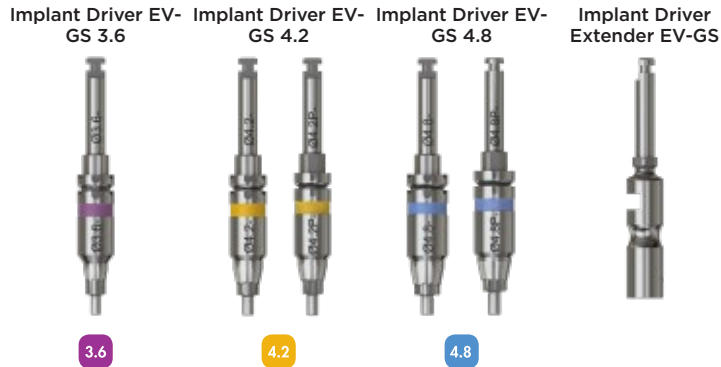

Version	Straight and Conical	Straight and Conical	Straight and Conical	
Ø mm	4.5	4.5	5.1	
Order No.	26016	26017	26018	26021

		P _{4.2}	P _{4.8}	
Version		Profile	Profile	
Ø mm		4.5	5.1	
Order No.		26019	26020	

Surgical Instruments Implant Driver EV-GS Implant Driver Profile EV-GS

Stainless steel (6), non-sterile

- For picking up and installing implant
- The guided surgery implant drivers can only engage into one single position in the implant
- Two grooves on the shaft indicate the corresponding implant lengths 8-11-15 mm and 6-9-13 mm, see illustration below
- One of the six is larger and indicates the one-position-only feature for pre-surgically manufactured Atlantis abutments
- Implant Driver Profile EV-GS has one notch indicating the direction of the slope of Astra Tech Implant EV Profile

Note: For use with Contra Angle or Torque Wrench EV Surgical Driver Handle

- The Extender EV-GS can be used for the drills and implant drivers in case of limited space between teeth.

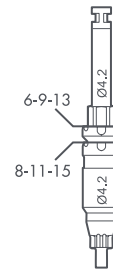

PositioningAid

Positioning System



Ø mm	Ø3.6	Ø4.2	Ø4.8
Implant length	8-11-15 mm	8-11-15 mm	8-11-15 mm
Type	Straight and Conical	Straight and Conical	Straight and Conical
Order No.	26039	26041	26043
Implant length	6-9-13 mm	6-9-13 mm	6-9-13 mm
Type	Straight and Conical	Straight and Conical	Straight and Conical
Order No.	26040	26042	26044

		P _{4.2}	P _{4.8}
Implant length		8-11-15 mm	8-11-15 mm
Type		Profile	Profile
Order No.		26045	26047
Implant length		6-9-13 mm	6-9-13 mm
Type		Profile	Profile
Order No.		26046	26048

Positioning System

Titanium (2), non-sterile

- Multiple use
- Color: corresponds to implant
- Laser markings: Implant Length 6-9-13 mm or 8-11-15 mm

Fixation System

Stabilization Abutments

Titanium (2), non-sterile

- Multiple-use
- Color: corresponds to the implant
- Stabilizes the guide for further implant treatment
- Laser markings: Implant length 6-9-13 mm or 8-11-15 mm and diameter

Stabilization Abutments

EV-Stabilization Abutment

EV-Stabilization Abutment

EV-Stabilization Abutment



3.6



4.2



4.8

Ø mm	Ø3.6	Ø4.2	Ø4.8
Implant length	8-11-15 mm	8-11-15 mm	8-11-15 mm
Order No.	26033	26035	26037
Implant length	6-9-13 mm	6-9-13 mm	6-9-13 mm
Order No.	26034	26036	26038

Fixation System

Stainless steel (6), sterile

Drill: Multiple-use

- Prepare the bone for the fixation screw

Screw: Single-use

- Secures the guide directly to the bone to avoid guide movement
- Hex on the top to fit the Hex driver EV manual with the ref. nr. 25771, 25772, 25773

Fixation System

Drill for guide fixation screw

Guide fixation screw



	14 mm	Ø2.0
Order No.	26050	26049

Sleeves

Sleeve-on-Drill™

Stainless steel (6), sterile

- Single use
- Laser marked with inner and outer sleeve diameter according to the corresponding drill type.
- Outer sleeve diameter = inner tube size
ND = narrow diameter
WD = wide diameter

Sleeve-on-Drill™

ND

WD



3.6 4.2 4.2
3.6S 4.2S 4.2C

4.8 4.8
4.8S 4.8C

Drill Type & Ø Inner	1-Sleeve Ø1.9 ND	1-Sleeve Ø1.9 WD
Order No.	26022	26027
Drill Type & Ø Inner	3/V-Sleeve Ø3.1 ND	3-Sleeve Ø3.1 WD
Order No.	26023	26028
Drill Type & Ø Inner	4/V-Sleeve Ø3.7 ND	4/V-Sleeve Ø3.7 WD
Order No.	26024	26029
Drill Type & Ø Inner	X-Sleeve Ø3.45 ND	5/V-Sleeve Ø4.3 WD
Order No.	26025	26030
Drill Type & Ø Inner	X-Sleeve Ø4.05 ND	X-Sleeve Ø4.05 WD
Order No.	26026	26031
Drill Type & Ø Inner	-	X-Sleeve Ø4.65 WD
Order No.	-	26032

Repair procedures

The Astra Tech Implant System EV proved a selection of unique products for safe and easy handling when meeting specific failures and other errors in the clinical situation. For different reasons abutments, implants or screws occasionally need to be removed and/or replaced.

The specific repair and retrieval products are used together with the ordinary instruments within Astra Tech Implant System EV.









Compatibility table

Identify the implant/abutment size for the implant.

Select the corresponding instruments;
see the order number in the table below.

Astra Tech Implant System® EV

	Astra Tech Implant EV					Astra Tech Implant EV Profile		Uni Abutment EV
								
Fragment Fork	25856	25856	25857	25857	25857	25857	25857	25857
Fragment Drill	25858	25858	25859	25859	25859	25859	25859	25859
Screw Extractor	25860	25860	25861	25861	25861	25861	25861	N/A
Thread Cleaner	25862	25863	25864	25865	25865	25864	25865	25864
Trephine Drill	25866	25867	25886 25868	25887 25869	25888 25870	25886 25868	25887 25869	N/A
Rescue Driver Uni Abutment EV								25794

Remove/retrieve screw fragments

Guiding Cylinder EV

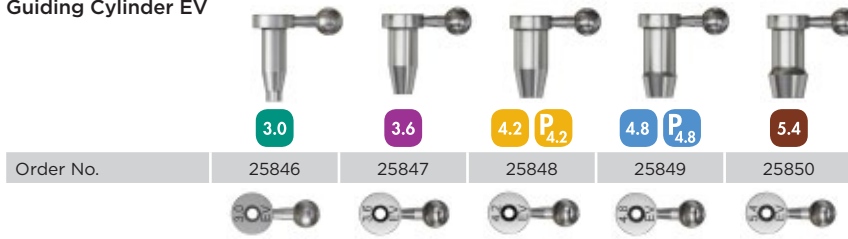

Guiding Cylinder EV

Stainless steel (6), non-sterile, single-use

- Guides the instruments into the center of the fragment
- Protects the internal threads in the implant
- Marked with diameter and EV
- Use together with Guiding Cylinder Handle and Fragment Drill or Fragment Fork

Guiding Cylinder Uni Abutment EV

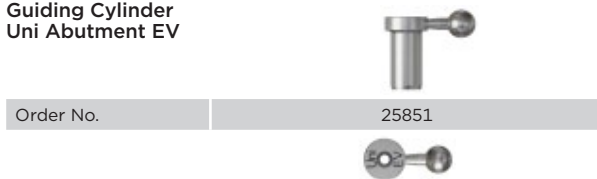

Guiding Cylinder Uni Abutment EV

Stainless steel (6), non-sterile, single-use

- Guides the instruments into the center of the fragment
- Protects the internal threads in the abutment
- Marked with diameter and EV
- Use together with Guiding Cylinder Handle and Fragment Drill or Fragment Fork for Uni Abutment EV

Guiding Cylinder Handle



Guiding Cylinder Handle

Stainless steel (6), non-sterile

- Adjustable handle for Guiding Cylinders

Fragment Fork

Tungsten-Carbide (9), non-sterile, single-use

- Used for retrieval of fractured abutment- and bridge screw fragments
- For manual use only
- Rotate the Fragment Fork counter-clockwise
- Marked with thread size
- Use together with Restorative Driver Handle EV

Note: Manual use only.

Fragment Fork



	M1.4/M1.6	M1.8/M2.0
Order No.	25856	25857

Fragment Drill

Shank: Stainless steel (6)

Cutting portion: Tungsten-Carbide (9)

Non-sterile, single-use

- Used for creating an indentation in the abutment- or bridge screw fragment
- Drill counter-clockwise
- Marked with diameter

Fragment Drill



Ø	0.8	1.0
Order No.	25858	25859

Screw Extractor

Stainless steel (6), non-sterile, single-use

- Used for retrieval of abutment screw fragments
- Rotate the screw extractor counter-clockwise
- Marked with diameter
- Use together with Surgical Driver Handle EV

Note: Manual use only.

Screw Extractor



Ø	0.8	1.0
Order No.	25860	25861

Clean internal threads

Thread Cleaner

Stainless steel (6), non-sterile, single-use

- Used for cleaning of threads internally in an implant/abutment
- Marked with thread size
- Use together with Restorative Driver Handle EV

Note: Manual use only.

Thread Cleaner



	M1.4	M1.6	M1.8	M2.0
Order No.	25862	25863	25864	25865

Remove Uni Abutments EV/implants

Rescue Driver Uni Abutment EV



Order No.	25794
-----------	-------

Rescue Driver Uni Abutment EV

Stainless steel (6), non-sterile

- Used for retrieval of Uni Abutment EV
- Used together with Surgical Driver Handle EV

Multibase Driver EV



Total length mm	19
Order No.	26204

Multibase Driver EV

Stainless steel (6), non-sterile

- Used for installation and removal of the Multibase EV Abutment
- The Surgical Driver Handle could be useful when removing the abutment to support the torque transferring

Trephine Drill



Length mm	6-17mm	6-17mm	6-13mm	6-17mm	6-13mm	6-17mm	6-13mm	6-17mm
Inner Ø mm	3.2	3.8	4.4	4.4	5.0	5.0	5.6	5.6
Outer Ø mm	4.0	4.6	5.2	5.2	5.8	5.8	6.4	6.4
Order No.	25866	25867	25886	25868	25887	25869	25888	25870

Trephine Drill

Stainless steel (6), non-sterile, single-use

- Used for the retrieval of partly or fully integrated implants.
- Marked with diameter and length.



Abutment Retriever



Order No.	22429
-----------	-------

Abutment Retriever

Stainless steel (6), non-sterile

- Use together with a Wrench.

Implant Retriever



Order No.	22192
-----------	-------

Implant Retriever

Stainless steel (6), non-sterile

- Use together with a Wrench.

General instruments

Torque Wrench EV

Stainless steel (6), non-sterile

- Use together with a Driver Handle.

Torque Wrench EV



Order No.	25774
-----------	-------

Torque Wrench EV, Surgical Driver Handle

Stainless steel (6), non-sterile

Torque Wrench EV, Restorative Driver Handle 4x4 low

Stainless steel (6), non-sterile

Torque Wrench EV, Surgical Driver Handle



Ø mm	8.9
Length mm	15.3
Order No.	25775

Torque Wrench EV, Restorative Driver Handle



Ø mm	8.9	8.9
Length mm	15.5	11.5
Order No.	25776	25777

Torque Wrench EV, Restorative Driver Handle 4x4 low



Ø mm	8.9
Length mm	9.7
Order No.	25730

Hex Driver EV Manual

Stainless steel (6), non-sterile

Hex Driver EV Manual



	Short	Intermediate	Long
Total length mm	20	31	38
Order No.	25771	25772	25773

Material specifications

Index (x) will be found at material description for specific products.

Metals

Type	Index	Composition/Designation	Standard
Titanium	1	Commercially pure titanium Grade 1-4	ASTM F67
Titanium alloy	2	Ti6Al4V Grade 5	ASTM F136
Gold-Platinum alloy	3	Au 60%, Pd 20%, Pt 19%, Ir 1%	
Gold alloy	4	Au 68.6%, Ag 11.85%, Cu 10.6%, Pd 3.95%, Zn 2.5%, Pt 2.45%, Ir 0.05% T _s - T _L 880-940°C	
Gold alloy, Valor	5	Pt 89.0%, Au 10.0%, Ir 1.0% T _s - T _L 1660-1710°C	
Stainless steel	6	Surgical stainless steel	ASTM F899
Aluminum	7	6061 T6	
TiN Coating	8	Titanium Nitride	
Tungsten-Carbide	9	Sandvik H 10F	ISO 4499





Plastic

Type	Index	Composition/Designation	Standard
PEEK	10	Polyetereterketon	
Burnout plastic, PMMA	11	Polymetylmetakrylat	ISO 8257 MN, 100-060
PC plastic	12	Polycarbonate	
PP plastic	13	Polypropylene	
PPSU plastic	14	Polyphenylsulfone	
Silicone	15	Polysiloxanes	
Nylon	16	Polyamid	
ABS Lustran 348	17	Acrylonitrile butadiene styrene	

Ceramic

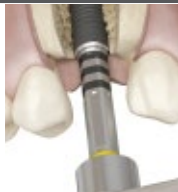
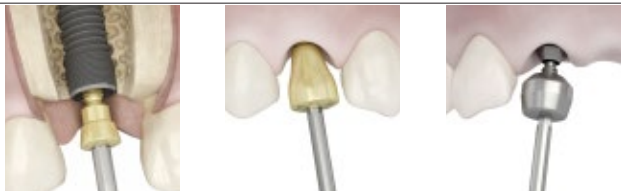
Type	Index	Composition/Designation	Standard
Zirconia	18	ZrO ₂	

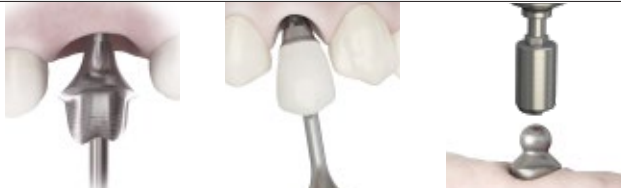
Torque guide – Recommended installation and tightening torque

Type of product installation		Torque – Ncm
<ul style="list-style-type: none"> Implant installations 		Maximum 45 Ncm
<ul style="list-style-type: none"> Cover screws Healing components 		5-10 Ncm Manual/ light finger force
<ul style="list-style-type: none"> Temporary abutments Temporary restorations on all levels 		15 Ncm
<ul style="list-style-type: none"> Final abutments Single tooth restorations on implant level 		25 Ncm
<ul style="list-style-type: none"> Final restorations on abutment level 		15 Ncm

Explanation of the symbols on labels and instructions for use

 Date of manufacture	 Single use	 Consult instructions for use ifu.dentsplysirona.com	Consult instructions for use.*
 Legal manufacturer.	 Do not re-sterilize	 LOT	LOT/BATCH number.
 Use by	 GOST is the valid quality certification system in Russian Federation.	 REF	Article number.
 STERILE R	 Products carrying the CE mark fulfill the requirements of the Medical Device Directive.	 QR code	Contains article number (GTIN number), lot number and quantity.
 Rx Only	0123 Identification of Notified Body.		
 NON STERILE	 Do not use if package is damaged	* To read PDF files you will need Adobe Reader. Download free of charge at get.adobe.com/reader .	

Index

Order by reference number

REF	page	REF	page		
22137	Titanium Bowl.....	48	25303	HealDesign™ EV 4.2 Ø 5 - 3.5 mm Triangular.....	8, 18
22179	BoneTrap.....	49	25304	HealDesign™ EV 4.2 Ø 6.5 - 3.5 mm Triangular.....	8, 18
22192	Implant Retriever.....	81	25305	HealDesign™ EV 4.8 Ø 5 - 3.5 mm Triangular.....	10, 18
22429	Abutment Retriever.....	81	25306	HealDesign™ EV 4.8 Ø 6.5 - 4.5 mm.....	10, 18, 60
22437	Forceps - 94 mm.....	48	25307	HealDesign™ EV 4.8 Ø 6.5 - 3.5 mm Triangular.....	10, 18
22740	Grinding Handle.....	55	25308	HealDesign™ EV 5.4 Ø 6.5 - 4.5 mm.....	12, 18
24482	Locator™ Core Tool.....	36, 54	25309	HealDesign™ EV 5.4 Ø 6.5 - 3.5 mm.....	12, 18
24483	Locator™ Process Kit.....	7, 9, 11, 37, 59, 61	25310	Direct Abutment™ EV Heal Cap 3.3.....	28
24484	Locator™ Abutment Pick-up.....	6, 8, 10, 36, 58, 60	25311	Direct Abutment™ EV Heal Cap 4.....	28
24485	Locator™ Abutment Replica.....	7, 9, 11, 36, 59, 61	25312	Direct Abutment™ EV Heal Cap 5.....	28
24486	Locator™ Insert Clear.....	7, 9, 11, 37, 59, 61	25313	Direct Abutment™ EV Heal Cap 6.....	28
24487	Locator™ Insert Pink.....	7, 9, 11, 37, 59, 61	25315	ZirDesign™ EV 3.6 Ø 5.5 - 1.5 mm Triangular.....	6, 23
24488	Locator™ Insert Blue.....	7, 9, 11, 37, 59, 61	25316	ZirDesign™ EV 3.6 Ø 4.5 - 2.5 mm.....	6, 23
24489	Locator™ Insert Green.....	7, 9, 11, 37, 59, 61	25317	ZirDesign™ EV 3.6 20° Ø 4.5 - 1.5 mm.....	6, 23
24492	Locator™ Insert Red.....	7, 9, 11, 37, 59, 61	25318	ZirDesign™ EV 4.2 Ø 5.5 - 1.5 mm Triangular.....	8, 23
24785	Irrigation Set.....	50, 51	25319	ZirDesign™ EV 4.2 Ø 7 - 1.5 mm Triangular.....	8, 23
24786	Tubing Extension with Luer.....	50, 51	25320	ZirDesign™ EV 4.2 Ø 5.5 - 2.5 mm.....	8, 23
24787	Tubing Cover Sleeve.....	50, 51	25321	ZirDesign™ EV 4.2 20° Ø 5.5 - 1.5 mm.....	8, 23
25160	Guide Drill EV.....	44	25322	ZirDesign™ EV 4.8 Ø 5.5 - 1.5 mm Triangular.....	10, 23
25161	Precision Drill EV.....	44	25323	ZirDesign™ EV 4.8 Ø 7 - 1.5 mm Triangular.....	10, 23
25162	1 - Twist Drill EV Ø 1.9, 6-17 mm.....	44	25324	ZirDesign™ EV 4.8 Ø 7 - 2.5 mm.....	10, 23
25163	1 - Twist Drill EV Ø 1.9, 6-13 mm.....	44	25325	ZirDesign™ EV 4.8 20° Ø 5.5 - 1.5 mm.....	10, 23
25164	2 - Step Drill EV Ø 1.9/2.5, 6-17 mm.....	44	25326	CastDesign™ EV 3.6.....	6, 23
25165	2 - Step Drill EV Ø 1.9/2.5, 6-13 mm.....	44	25327	CastDesign™ EV 4.2.....	8, 23
25168	3 - Step Drill EV Ø 2.5/3.1, 6-17 mm.....	44	25328	CastDesign™ EV 4.8.....	10, 23
25169	3 - Step Drill EV Ø 2.5/3.1, 6-13 mm.....	44	25329	CastDesign™ EV 5.4.....	12, 23
25172	4 - Step Drill EV Ø 3.1/3.7, 6-17 mm.....	44	25330	TiDesign™ EV 3.0 Ø 4 - 2.5 mm.....	4, 22
25173	4 - Step Drill EV Ø 3.1/3.7, 6-13 mm.....	44	25331	TiDesign™ EV 3.0 Ø 4 - 1.5 mm.....	4, 22
25176	5 - Step Drill EV Ø 3.7/4.3, 6-17 mm.....	44	25332	TiDesign™ EV 3.0 15° Ø 4 - 1.5 mm.....	4, 22
25177	5 - Step Drill EV Ø 3.7/4.3, 6-13 mm.....	44	25333	TiDesign™ EV 3.6 Ø 5.5 - 1.5/2.5 mm Triangular.....	6, 22
25180	6 - Step Drill EV Ø 4.3/4.9, 6-17 mm.....	44	25334	TiDesign™ EV 3.6 Ø 4.5 - 2.5/3.5 mm.....	6, 22
25181	6 - Step Drill EV Ø 4.3/4.9, 6-13 mm.....	44	25335	TiDesign™ EV 3.6 20° Ø 4.5 - 1.5/2.5 mm.....	6, 22
25188	A/B - Conical Drill EV Ø 3.1/4.2.....	46	25336	TiDesign™ EV 4.2 Ø 5.5 - 1.5/2.5 mm Triangular.....	8, 22
25190	A/B - Conical Drill EV Ø 3.7/4.8.....	46	25337	TiDesign™ EV 4.2 Ø 7 - 1.5/2.5 mm Triangular.....	8, 22
25193	B - Cortical Drill EV Ø 2.5/3.0.....	45	25338	TiDesign™ EV 4.2 Ø 5.5 - 2.5/3.5 mm.....	8, 22
25195	B - Cortical Drill EV Ø 3.1/3.6.....	45	25339	TiDesign™ EV 4.2 20° Ø 5.5 - 1.5/2.5 mm.....	8, 22
25197	B - Cortical Drill EV Ø 3.7/4.2.....	45	25340	TiDesign™ EV 4.8 Ø 5.5 - 1.5/2.5 mm Triangular.....	10, 22
25199	B - Cortical Drill EV Ø 4.3/4.8.....	45	25341	TiDesign™ EV 4.8 Ø 7 - 1.5/2.5 mm Triangular.....	10, 22
25201	B - Cortical Drill EV Ø 4.9/5.4.....	45	25342	TiDesign™ EV 4.8 Ø 7 - 2.5/3.5 mm.....	10, 22
25203	Abutment Screw EV 3.0.....	21	25343	TiDesign™ EV 4.8 20° Ø 5.5 - 1.5/2.5 mm.....	10, 22
25204	Abutment Screw EV 3.6.....	21	25344	TiDesign™ EV 5.4 Ø 7 - 2.5/3.5 mm.....	12, 22
25205	Abutment Screw EV 4.2.....	21, 65	25345	TiDesign™ EV 5.4 Ø 7 - 1.5/2.5 mm.....	12, 22
25206	Abutment Screw EV 4.8.....	21, 65	25346	Direct EV API™ Ø 3.3.....	28
25207	Abutment Screw EV 5.4.....	21	25347	Direct EV API™ Ø 4.....	28
25280	Cover Screw EV 3.0.....	4, 17	25348	Direct EV API™ Ø 5.....	28, 59, 61
25281	Cover Screw EV 3.6 - 0 mm.....	6, 17	25349	Direct EV API™ Ø 6.....	28, 59, 61
25282	Cover Screw EV 4.2 - 0 mm.....	8, 17	25361	Direct Abutment™ EV 3.0 Ø 3.3 - 1 mm.....	5, 27
25283	Cover Screw EV 4.8 - 0 mm.....	10, 17	25362	Direct Abutment™ EV 3.0 Ø 3.3 - 2 mm.....	5, 27
25284	Cover Screw EV 5.4 - 0 mm.....	12, 17	25363	Direct Abutment™ EV 3.0 Ø 3.3 - 3 mm.....	5, 27
25285	Healing Uni EV 3.6 - 2 mm/Ø 4.....	6, 19	25364	Direct Abutment™ EV 3.6 Ø 4 - 1 mm.....	7, 27
25286	Healing Uni EV 3.6 - 4 mm/Ø 4.....	6, 19	25365	Direct Abutment™ EV 3.6 Ø 4 - 2 mm.....	7, 27
25287	Healing Uni EV 3.6 - 6 mm/Ø 4.....	6, 19	25366	Direct Abutment™ EV 3.6 Ø 4 - 3 mm.....	7, 27
25288	Healing Uni EV 4.2 - 2 mm/Ø 4.....	8, 19, 58	25367	Direct Abutment™ EV 4.2 Ø 5 - 1 mm.....	9, 27, 59
25289	Healing Uni EV 4.2 - 4 mm/Ø 4.....	8, 19, 58	25368	Direct Abutment™ EV 4.2 Ø 5 - 2 mm.....	9, 27, 59
25290	Healing Uni EV 4.2 - 6 mm/Ø 4.....	8, 19, 58	25369	Direct Abutment™ EV 4.2 Ø 5 - 3 mm.....	9, 27, 59
25297	HealDesign™ EV 3.0 Ø 3.5 - 4.5 mm.....	4, 18	25370	Direct Abutment™ EV 4.8 Ø 5 - 1 mm.....	11, 27, 61
25298	HealDesign™ EV 3.0 Ø 3.5 - 3.5 mm.....	4, 18	25371	Direct Abutment™ EV 4.8 Ø 5 - 2 mm.....	11, 27, 61
25299	HealDesign™ EV 3.6 Ø 4 - 4.5 mm.....	6, 18	25372	Direct Abutment™ EV 4.8 Ø 5 - 3 mm.....	11, 27, 61
25300	HealDesign™ EV 3.6 Ø 4 - 3.5 mm.....	6, 18	25373	Direct Abutment™ EV 5.4 Ø 6 - 1 mm.....	13, 27
25301	HealDesign™ EV 3.6 Ø 5 - 3.5 mm Triangular.....	6, 18	25374	Direct Abutment™ EV 5.4 Ø 6 - 2 mm.....	13, 27
25302	HealDesign™ EV 4.2 Ø 5 - 4.5 mm.....	8, 18, 58	25375	Direct Abutment™ EV 5.4 Ø 6 - 3 mm.....	13, 27

REF	page
25377	Implant Driver EV 3.0 Long.....48
25378	Implant Driver EV 3.6 Short.....48
25379	Implant Driver EV 3.6 Long.....48
25380	Implant Driver EV 4.2 Short.....48
25381	Implant Driver EV 4.2 Long.....48
25382	Implant Driver EV 4.8 Short.....48
25383	Implant Driver EV 4.8 Long.....48
25384	Implant Driver EV 5.4 Short.....48
25385	Implant Driver EV 5.4 Long.....48
25396	Direct Abutment™ EV Pick-Up 3.3.....28
25397	Direct Abutment™ EV Pick-Up 4.....28
25398	Direct Abutment™ EV Pick-Up 5.....28
25399	Direct Abutment™ EV Pick-Up 6.....28
25401	Direct Abutment™ EV Replica 3.3.....28
25402	Direct Abutment™ EV Replica 4.....28
25403	Direct Abutment™ EV Replica 5.....28
25404	Direct Abutment™ EV Replica 6.....28
25406	Direct Abutment™ EV Burnout Cap 3.3.....28
25407	Direct Abutment™ EV Burnout Cap 4.....28
25408	Direct Abutment™ EV Burnout Cap 5.....28
25409	Direct Abutment™ EV Burnout Cap 6.....28
25411	B 6 mm - Cortical Drill EV Ø 3.1/3.6.....46
25412	A 6 mm - Cortical Drill EV Ø 3.7/3.9.....45
25419	B 6 mm - Cortical Drill EV Ø 3.7/4.2.....46
25420	A 6 mm - Cortical Drill EV Ø 4.3/4.5.....45
25421	B 6 mm - Cortical Drill EV Ø 4.3/4.8.....46
25422	A 6 mm - Cortical Drill EV Ø 4.9/5.1.....45
25423	A - Cortical Drill EV Ø 2.5/2.7.....45
25424	B 6 mm - Cortical Drill EV Ø 4.9/5.4.....46
25431	A - Cortical Drill EV Ø 4.9/5.1.....45
25464	Implant Driver Profile EV 4.2 Short.....63
25465	Implant Driver Profile EV 4.2 Long.....63
25466	Implant Driver Profile EV 4.8 Short.....63
25467	Implant Driver Profile EV 4.8 Long.....63
25476	Lab Abutment Screw EV 3.0.....5, 26, 55
25477	Lab Abutment Screw EV 3.6 - M1.6.....7, 26, 55
25478	Lab Abutment Screw EV 4.2 - M1.8.....9, 26, 55, 59, 67
25479	Lab Abutment Screw EV 4.8 - M2.....11, 26, 55, 61, 67
25480	Lab Abutment Screw EV 5.4 - M2.....13, 26, 55
25481	Bridge Screw EV - M1.8.....5, 7, 9, 11, 13, 30, 59, 61
25482	X - Step Drill EV Ø 2.5/2.85, 6-13 mm.....47
25483	X - Step Drill EV Ø 3.1/3.45, 6-13 mm.....47
25484	X - Step Drill EV Ø 3.7/4.05, 6-13 mm.....47
25485	X - Step Drill EV Ø 4.3/4.65, 6-13 mm.....47
25486	X - Step Drill EV Ø 4.9/5.25, 6-13 mm.....47
25487	A 6 mm - Cortical Drill EV Ø 3.1/3.3.....45
25488	A - Cortical Drill EV Ø 3.1/3.3.....45
25490	A - Cortical Drill EV Ø 3.7/3.9.....45
25492	A - Cortical Drill EV Ø 4.3/4.5.....45
25494	Direct Abutment™ EV 4.2 Ø 6 - 1 mm.....9, 27, 59
25495	Direct Abutment™ EV 4.2 Ø 6 - 2 mm.....9, 27, 59
25496	Direct Abutment™ EV 4.2 Ø 6 - 3 mm.....9, 27, 59
25497	Direct Abutment™ EV 4.8 Ø 6 - 1 mm.....11, 27, 61
25498	Direct Abutment™ EV 4.8 Ø 6 - 2 mm.....11, 27, 61
25499	Direct Abutment™ EV 4.8 Ø 6 - 3 mm.....11, 27, 61
25500	Radiographic Implant Guides EV.....49
25501	HealDesign™ EV 4.2 Ø 5 - 3.5 mm.....8, 18, 58
25502	HealDesign™ EV 4.8 Ø 5 - 3.5 mm.....10, 18, 60
25503	TempDesign™ EV 3.0.....4, 21
25504	TempDesign™ EV 3.6.....6, 21
25505	TempDesign™ EV 4.2.....8, 21
25506	TempDesign™ EV 4.8.....10, 21
25507	TempDesign™ EV 5.4.....12, 21
25528	Lab Pin Design EV 3.0/3.6.....5, 7, 26, 55
25530	Lab Pin Design EV 4.2/4.8/5.4.....9, 11, 13, 26, 55, 59, 61
25534	Implant Transfer EV 3.0 Long.....5, 26
25535	Implant Transfer EV 3.6 Short.....7, 26
25536	Implant Transfer EV 3.6 Long.....7, 26
25537	Implant Transfer EV 4.2 Short.....9, 26
25538	Implant Transfer EV 4.2 Long.....9, 26
25539	Implant Transfer EV 4.8 Short.....11, 26

REF	page
25540	Implant Transfer EV 4.8 Long.....11, 26
25541	Implant Transfer EV 5.4 Short.....13, 26
25542	Implant Transfer EV 5.4 Long.....13, 26
25543	Implant Replica EV 3.0.....5, 26
25544	Implant Replica EV 3.6.....7, 26
25545	Implant Replica EV 4.2.....9, 26
25546	Implant Replica EV 4.8.....11, 26
25547	Implant Replica EV 5.4.....13, 26
25555	Uni Abutment EV 3.0 - 2 mm.....4, 29
25556	Uni Abutment EV 3.0 - 3 mm.....4, 29
25557	Uni Abutment EV 3.0 - 5 mm.....4, 29
25558	Uni Abutment EV 3.6 - 1 mm.....6, 29
25559	Uni Abutment EV 3.6 - 2 mm.....6, 29
25560	Uni Abutment EV 3.6 - 3 mm.....6, 29
25561	Uni Abutment EV 3.6 - 5 mm.....6, 29
25562	Uni Abutment EV 4.2 - 1 mm.....8, 29, 58
25563	Uni Abutment EV 4.2 - 2 mm.....8, 29, 58
25564	Uni Abutment EV 4.2 - 3 mm.....8, 29, 58
25565	Uni Abutment EV 4.2 - 5 mm.....8, 29, 58
25566	Uni Abutment EV 4.8 - 1 mm.....10, 29, 60
25567	Uni Abutment EV 4.8 - 2 mm.....10, 29, 60
25568	Uni Abutment EV 4.8 - 3 mm.....10, 29, 60
25569	Uni Abutment EV 4.8 - 5 mm.....10, 29, 60
25570	Uni Abutment EV 5.4 - 1 mm.....12, 29
25571	Uni Abutment EV 5.4 - 2 mm.....12, 29
25572	Uni Abutment EV 5.4 - 3 mm.....12, 29
25573	Uni Abutment EV 5.4 - 5 mm.....12, 29
25574	Healing Uni EV 3.0 - 2 mm.....4, 19
25575	Healing Uni EV 3.0 - 3 mm.....4, 19
25576	Healing Uni EV 3.0 - 4 mm.....4, 19
25577	Healing Uni EV 3.0 - 6 mm.....4, 19
25578	Healing Uni EV 3.6 - 3 mm/Ø 4.....6, 19
25579	Healing Uni EV 4.2 - 3 mm/Ø 4.....8, 19, 58
25582	Cover Screw Profile EV 4.2.....58, 63
25583	Cover Screw Profile EV 4.8.....60, 63
25584	HealDesign™ Profile EV 4.2, Ø 5.....58, 64
25585	HealDesign™ Profile EV 4.2, Ø 5 Triangular.....58, 64
25586	HealDesign™ Profile EV 4.2, Ø 6.5 Triangular.....58, 64
25587	HealDesign™ Profile EV 4.2, Ø 5.....58, 64
25588	HealDesign™ Profile EV 4.8, Ø 5 Triangular.....60, 64
25589	HealDesign™ Profile EV 4.8, Ø 6.5.....60, 64
25590	HealDesign™ Profile EV 4.8, Ø 6.5 Triangular.....60, 64
25591	HealDesign™ Profile EV 4.8, Ø 5.....60, 64
25592	TiDesign™ Profile EV 4.2, Ø 5.5 Triangular.....58, 66
25593	TiDesign™ Profile EV 4.2, Ø 7.0 Triangular.....58, 66
25594	TiDesign™ Profile EV 4.2, Ø 5.5.....58, 66
25595	TiDesign™ Profile EV 4.2, Ø 5.5 15°.....58, 66
25596	TiDesign™ Profile EV 4.8, Ø 5.5 Triangular.....60, 66
25597	TiDesign™ Profile EV 4.8, Ø 7.0 Triangular.....60, 66
25598	TiDesign™ Profile EV 4.8, Ø 7.0.....60, 66
25599	TiDesign™ Profile EV 4.8, Ø 5.5 15°.....60, 66
25606	Implant Transfer Profile EV 4.2, Short.....59, 67
25607	Implant Transfer Profile EV 4.2, Long.....59, 67
25608	Implant Transfer Profile EV 4.8, Short.....61, 67
25609	Implant Transfer Profile EV 4.8, Long.....61, 67
25610	Implant Replica Profile EV 4.2.....59, 67
25611	Implant Replica Profile EV 4.8.....61, 67
25615	Uni Abutment EV Replica.....5, 7, 9, 11, 13, 30, 59, 61
25616	Uni Abutment EV Heal Cap Ø 4.3 - 4.4 mm.....4, 6, 8, 10, 12, 30, 58, 60
25617	Uni Abutment EV Heal Cap Ø 5.5 - 4.4 mm.....4, 6, 8, 10, 12, 30, 58, 60
25619	Angled Abutment EV 3.6 20° - 1 mm.....6, 31
25620	Angled Abutment EV 3.6 20° - 2 mm.....6, 31
25621	Angled Abutment EV 3.6 20° - 1 mm NI.....6, 31
25622	Angled Abutment EV 3.6 20° - 2 mm NI.....6, 31
25625	Angled Abutment EV 4.2 20° - 1 mm.....8, 31
25626	Angled Abutment EV 4.2 20° - 2 mm.....8, 31
25627	Angled Abutment EV 4.2 20° - 1 mm NI.....8, 31
25628	Angled Abutment EV 4.2 20° - 2 mm NI.....8, 31
25631	Angled Abutment EV 4.8 20° - 1 mm.....10, 31

REF	page
25632	Angled Abutment EV 4.8 20° - 2 mm10, 31
25633	Angled Abutment EV 4.8 20° - 1 mm NI10, 31
25634	Angled Abutment EV 4.8 20° - 2 mm NI10, 31
25637	Radiographic Implant Guides Profile EV61
25638	OD Cylinder EV 7, 9, 11, 38, 59, 61
25643	Lab Abutment Pin EV Short5, 7, 9, 11, 13, 30, 55, 59, 61
25644	Lab Abutment Pin EV Intermediate...5, 7, 9, 11, 13, 30, 55, 59, 61
25645	Lab Abutment Pin EV Long5, 7, 9, 11, 13, 30, 55, 59, 61
25647	Uni Abutment EV Semi-Burnout Cylinder5, 7, 9, 11, 13, 30, 59, 61
25649	Uni Abutment EV Burnout Cylinder5, 7, 9, 11, 13, 30, 59, 61
25650	Angled Abutment EV Heal Cap6, 8, 10, 31, 58, 60
25652	Angled Abutment EV Replica7, 9, 11, 31, 59, 61
25653	Angled Abutment EV Semi-Burnout Cylinder ...7, 9, 11, 31, 59, 61
25654	Angled Abutment EV Temporary Cylinder7, 9, 11, 31, 59, 61
25655	Angled Abutment EV Burnout Cylinder7, 9, 11, 31, 59, 61
25656	Lab Bridge Screw EV - M1.85, 7, 9, 11, 13, 30, 55, 59, 61
25657	Locator™ Abutment EV 3.6 - 1 mm6, 36
25658	Locator™ Abutment EV 3.6 - 2 mm6, 36
25659	Locator™ Abutment EV 3.6 - 3 mm6, 36
25660	Locator™ Abutment EV 3.6 - 4 mm6, 36
25661	Locator™ Abutment EV 3.6 - 5 mm6, 36
25662	Locator™ Abutment EV 4.2 - 1 mm8, 36, 58
25663	Locator™ Abutment EV 4.2 - 2 mm8, 36, 58
25664	Locator™ Abutment EV 4.2 - 3 mm8, 36, 58
25665	Locator™ Abutment EV 4.2 - 4 mm8, 36, 58
25666	Locator™ Abutment EV 4.2 - 5 mm8, 36, 58
25667	Locator™ Abutment EV 4.8 - 1 mm10, 36, 58
25668	Locator™ Abutment EV 4.8 - 2 mm10, 36, 60
25669	Locator™ Abutment EV 4.8 - 3 mm10, 36, 60
25670	Locator™ Abutment EV 4.8 - 4 mm10, 36, 60
25671	Locator™ Abutment EV 4.8 - 5 mm10, 36, 60
25679	Locator™ Insert Grey 7, 9, 11, 37, 59, 61
25684	Ball Abutment EV 3.6 - 1 mm6, 37
25685	Ball Abutment EV 3.6 - 2 mm6, 37
25686	Ball Abutment EV 3.6 - 3 mm6, 37
25687	Ball Abutment EV 3.6 - 4 mm6, 37
25688	Ball Abutment EV 3.6 - 5 mm6, 37
25689	Ball Abutment EV 3.6 - 7 mm6, 37
25690	Ball Abutment EV 4.2 - 1 mm8, 37, 58
25691	Ball Abutment EV 4.2 - 2 mm8, 37, 58
25692	Ball Abutment EV 4.2 - 3 mm8, 37, 58
25693	Ball Abutment EV 4.2 - 4 mm8, 37, 58
25694	Ball Abutment EV 4.2 - 5 mm8, 37, 58
25695	Ball Abutment EV 4.2 - 7 mm8, 37, 58
25696	Ball Abutment EV 4.8 - 1 mm10, 38, 60
25697	Ball Abutment EV 4.8 - 2 mm10, 38, 60
25698	Ball Abutment EV 4.8 - 3 mm10, 38, 60
25699	Ball Abutment EV 4.8 - 4 mm10, 38, 60
25700	Ball Abutment EV 4.8 - 5 mm10, 38, 60
25701	Ball Abutment EV 4.8 - 7 mm10, 38, 60
25708	Uni Driver EV29, 53
25710	Implant Depth Gauge EV48
25711	Mucosal Punch EV Ø 3.5.....49
25712	Mucosal Punch EV Ø 4.....49
25713	Mucosal Punch EV Ø 4.5.....49
25714	Mucosal Punch EV Ø 5.....49
25715	Mucosal Punch EV Ø 5.5.....49
25721	Large Tray EV, Overlay 1.....40
25722	Large Tray EV, Overlay 2.....40
25723	Large Tray EV, Overlay 3.....40
25724	Small Tray EV, Overlay Restorative.....41
25725	Small Tray EV, Overlay Surgical.....41
25726	Abutment Depth Gauge EV 5.454
25727	Hex Driver EV Machine Intermediate, 24 mm.....49, 52
25728	Hex Driver EV Machine Long, 35 mm49, 52
25730	Torque Wrench EV Restorative Driver Handle 4x4 Low54, 82
25731	Mucosal Punch EV Ø 6.5.....49
25756	TempDesign™ Profile EV 4.2.....58, 65
25757	TempDesign™ Profile EV 4.8.....60, 65
25764	Direct Driver EV Ø3.3 Ø4.....27, 53
25765	Direction Indicator EV48

REF	page
25766	Locator™ Driver EV32, 53
25768	Ball Abutment Driver EV38, 54
25769	Large Tray EV40, 69
25770	Small Tray EV (no overlay)41
25771	Hex Driver EV Manual Short, 20 mm49, 52, 82
25772	Hex Driver EV Manual Intermediate, 31 mm49, 52, 82
25773	Hex Driver EV Manual Long, 38 mm49, 52, 82
25774	Torque Wrench EV49, 54, 82
25775	Torque Wrench EV Surgical Driver Handle.....49, 82
25776	Torque Wrench EV Restorative Driver Handle54, 82
25777	Torque Wrench EV Restorative Driver Handle Low54, 82
25778	Polishing Protector Uni EV55
25780	V - Twist Drill EV Ø 2.5, 6-17 mm47
25781	V - Twist Drill EV Ø 3.1, 6-17 mm47
25782	V - Twist Drill EV Ø 3.7, 6-17 mm47
25783	V - Twist Drill EV Ø 4.3, 6-17 mm47
25784	V - Twist Drill EV Ø 4.9, 6-17 mm47
25790	Hex Driver EV Machine Short, 20 mm49, 52
25792	Abutment Depth Gauge EV 3.0/3.654
25793	Abutment Depth Gauge EV 4.2/4.854
25794	Rescue Driver Uni Abutment EV81
25795	HealDesign™ EV 3.0 Ø 3.5 - 6.5 mm4, 18
25796	HealDesign™ EV 3.6 Ø 4 - 6.5 mm6, 18
25797	HealDesign™ EV 4.2 Ø 5 - 6.5 mm8, 18, 56
25798	HealDesign™ EV 4.8 Ø 6.5 - 6.5 mm10, 18, 60
25799	HealDesign™ EV 5.4 Ø 6.5 - 6.5 mm12, 18
25826	Ball Abutment EV Replica 7, 9, 11, 38, 59, 61
25827	Dalbo Plus Duplicating Aid38
25834	Dalbo Plus Female Part TE Basic, complete 7, 9, 11, 38, 59, 61
25835	Dalbo Plus Screwdriver / Activator38, 54
25843	Locator™ Insert Orange 7, 9, 11, 37, 59, 61
25844	Dalbo Plus Lamellae retention Insert E38
25845	Small Tray EV, Overlay Storage41
25846	Guiding Cylinder EV 3.079
25847	Guiding Cylinder EV 3.679
25848	Guiding Cylinder EV 4.2, P4.279
25849	Guiding Cylinder EV 4.8, P4.879
25850	Guiding Cylinder EV 5.479
25851	Guiding Cylinder Uni Abutment EV79
25855	Guiding Cylinder Handle79
25856	Fragment Fork M1.4/M1.680
25857	Fragment Fork M1.8/M2.080
25858	Fragment Drill Ø 0.880
25859	Fragment Drill Ø 1.080
25860	Screw Extractor 0.880
25861	Screw Extractor 1.080
25862	Thread Cleaner M1.480
25863	Thread Cleaner M1.680
25864	Thread Cleaner M1.880
25865	Thread Cleaner M2.080
25866	Trephine Drill 3.0, 6-17 mm81
25867	Trephine Drill 3.6, 6-17 mm81
25868	Trephine Drill 4.2, P4.2, 6-17 mm81
25869	Trephine Drill 4.8, P4.8, 6-17 mm81
25870	Trephine Drill 5.4, 6-17 mm81
25886	Trephine Drill 4.2, P4.2, 6-13 mm81
25887	Trephine Drill 4.8, P4.8, 6-13 mm81
25888	Trephine Drill 5.4, 6-13 mm81
25890	Angled Abutment Profile EV 4.2, 20°58, 66
25891	Angled Abutment Profile EV 4.2, 20°58, 66
25892	Angled Abutment Profile EV 4.8, 20°60, 66
25893	Angled Abutment Profile EV 4.8, 20°60, 66
25901	HealDesign™ EV 3.0, Ø 3.5 - 2.5 mm4, 18
25902	HealDesign™ EV 3.6, Ø 4 - 2.5 mm4, 18
25903	HealDesign™ EV 3.6, Ø 4 - 5 mm4, 18
25904	HealDesign™ EV 3.6, Ø 5 - 4.5 mm4, 18
25905	HealDesign™ EV 3.6, Ø 5 - 6.5 mm4, 18
25906	HealDesign™ EV 3.6, Ø 6 - 3.5 mm4, 18
25907	HealDesign™ EV 3.6, Ø 6 - 4.5 mm4, 18
25908	HealDesign™ EV 4.2, Ø 5 - 2.5 mm8, 18, 58
25909	HealDesign™ EV 4.2, Ø 6.5 - 2.5 mm8, 18, 58

REF	page
25910	HealDesign™ EV 4.2, Ø 6.5 - 3.5 mm.....8, 18, 58
25911	HealDesign™ EV 4.2, Ø 6.5 - 4.5 mm.....8, 18, 58
25912	HealDesign™ EV 4.2, Ø 6.5 - 6.5 mm.....8, 18, 58
25913	HealDesign™ EV 4.8, Ø 5 - 2.5 mm.....10, 18, 60
25914	HealDesign™ EV 4.8, Ø 5 - 4.5 mm.....10, 18, 60
25915	HealDesign™ EV 4.8, Ø 5 - 6.5 mm.....10, 18, 60
25916	HealDesign™ EV 4.8, Ø 6.5 - 2.5 mm.....10, 18, 60
25917	HealDesign™ EV 4.8, Ø 6.5 - 3.5 mm.....10, 18, 60
25918	HealDesign™ EV 4.8, Ø 7.5 - 3.5 mm.....10, 18, 60
25919	HealDesign™ EV 4.8, Ø 7.5 - 4.5 mm.....10, 18, 60
25920	HealDesign™ EV 3.6, Ø 5 - 3.5 mm.....6, 18
25921	HealDesign™ EV 5.4, Ø 6.5 - 2.5 mm.....12, 18
25922	HealDesign™ EV 5.4, Ø 7.5 - 3.5 mm.....12, 18
25923	HealDesign™ EV 5.4, Ø 7.5 - 4.5 mm.....12, 18
25924	TitaniumBase EV 3.0 Ø 4 - 5 mm.....5, 24
25925	TitaniumBase EV 3.0 Ø 4 - 6 mm.....5, 24
25926	TitaniumBase EV 3.6 Ø 4.1 - 5 mm.....7, 24
25927	TitaniumBase EV 3.6 Ø 4.1 - 6 mm.....7, 24
25928	TitaniumBase EV 4.2 Ø 4.7 - 5 mm.....9, 24
25929	TitaniumBase EV 4.2 Ø 4.7 - 6 mm.....9, 24
25930	TitaniumBase EV 4.8 Ø 5 - 5 mm.....11, 24
25931	TitaniumBase EV 4.8 Ø 5 - 6 mm.....11, 24
25932	TitaniumBase EV 4.8 Ø 5.5 - 5 mm.....13, 24
25933	TitaniumBase EV 4.8 Ø 5.5 - 6 mm.....13, 24
25952	Uni Abutment EV Heal Cap Short Ø 4.3 - 3.4 mm4, 6, 8, 10, 12, 30, 58, 60
25953	Uni Abutment EV Heal Cap Short Ø 5.5 - 3.4 mm4, 6, 8, 10, 12, 30, 58, 60
25982	Small Tray EV including overlay Restorative.....41
25983	Small Tray EV including overlay Surgical.....41
25984	Small Tray EV including overlay Storage.....41
25985	V - Twist Drill EV Ø 2.5, 6-13 mm.....47
25986	V - Twist Drill EV Ø 3.1, 6-13 mm.....47
25987	V - Twist Drill EV Ø 3.7, 6-13 mm.....47
25988	V - Twist Drill EV Ø 4.3, 6-13 mm.....47
25989	V - Twist Drill EV Ø 4.9, 6-13 mm.....47
25990	X - Step Drill EV Ø 2.5/2.85, 6-17 mm.....47
25991	X - Step Drill EV Ø 3.1/3.45, 6-17 mm.....47
25992	X - Step Drill EV Ø 3.7/4.05, 6-17 mm.....47
25993	X - Step Drill EV Ø 4.3/4.65, 6-17 mm.....47
25994	X - Step Drill EV Ø 4.9/5.25, 6-17 mm.....47
26000	Conical Drill EV-GS, 4.2C, Ø 3.1/4.2, 9-13.....73
26001	Conical Drill EV-GS, 4.2C, Ø 3.1/4.2, 8-11-15.....73
26002	Conical Drill EV-GS, 4.8C, Ø 3.7/4.8, 9-13.....73
26003	Conical Drill EV-GS, 4.8C, Ø 3.7/4.8, 8-11-15.....73
26004	Cortical Drill EV-GS, 3.6, Ø 3.1/3.3.....73
26005	Cortical Drill EV-GS, 3.6, Ø 3.1/3.6.....73
26006	Cortical Drill EV-GS, 4.2, Ø 3.7/3.9.....73
26007	Cortical Drill EV-GS, 4.2, Ø 3.7/4.2.....73
26008	Cortical Drill EV-GS, 4.8, Ø 4.3/4.5.....73
26009	Cortical Drill EV-GS, 4.8, Ø 4.3/4.8.....73
26010	Punch EV-GS Ø 3.6.....71
26011	Punch EV-GS Ø 4.2.....71
26012	Punch EV-GS Ø 4.8.....71
26013	Initial Drill Ø 3.6.....71
26014	Initial Drill Ø 4.2.....71
26015	Initial Drill Ø 4.8.....71
26016	Implant Driver EV-GS 3.6.....75
26017	Implant Driver EV-GS 4.2.....75
26018	Implant Driver EV-GS 4.8.....75
26019	Implant Driver EV-GS Profile 4.2.....75
26020	Implant Driver EV-GS Profile 4.8.....75
26021	Implant Driver Extender EV-GS.....48, 75
26022	Sleeve-on-Drill™ 1-Sleeve Ø1.9 ND.....76
26023	Sleeve-on-Drill™ 3/V-Sleeve Ø3.1 ND.....76
26024	Sleeve-on-Drill™ 4/V-Sleeve Ø3.7 ND.....76
26025	Sleeve-on-Drill™ X-Sleeve Ø3.45 ND.....76
26026	Sleeve-on-Drill™ X-Sleeve Ø4.05 ND.....76
26027	Sleeve-on-Drill™ 1-Sleeve Ø1.9 WD.....76
26028	Sleeve-on-Drill™ 3-Sleeve Ø3.1 WD.....76
26029	Sleeve-on-Drill™ 4/V-Sleeve Ø3.7 WD.....76

REF	page
26030	Sleeve-on-Drill™ 5/V-Sleeve Ø4.3 WD.....76
26031	Sleeve-on-Drill™ X-Sleeve Ø4.05 WD.....76
26032	Sleeve-on-Drill™ X-Sleeve Ø4.65 WD.....76
26033	EV-Stabilization Abutment 3.6, 8-11-15 mm.....76
26034	EV-Stabilization Abutment 3.6, 6-9-13 mm.....76
26035	EV-Stabilization Abutment 4.2, 8-11-15 mm.....76
26036	EV-Stabilization Abutment 4.2, 6-9-13 mm.....76
26037	EV-Stabilization Abutment 4.8, 8-11-15 mm.....76
26038	EV-Stabilization Abutment 4.8, 6-9-13 mm.....76
26039	EV-PositionAid 3.6, 8-11-15 mm.....75
26040	EV-PositionAid 3.6, 6-9-13 mm.....75
26041	EV-PositionAid 4.2, 8-11-15 mm.....75
26042	EV-PositionAid 4.2, 6-9-13 mm.....75
26043	EV-PositionAid 4.8, 8-11-15 mm.....75
26044	EV-PositionAid 4.8, 6-9-13 mm.....75
26045	EV-PositionAid Profile 4.2, 8-11-15 mm.....75
26046	EV-PositionAid Profile 4.2, 6-9-13 mm.....75
26047	EV-PositionAid Profile 4.8, 8-11-15 mm.....75
26048	EV-PositionAid Profile 4.8, 6-9-13 mm.....75
26049	Guide fixation screw.....76
26050	Drill for guide fixation screw.....76
26051	Drill EV-GS, narrow diam. Sleeve, Ø1.9 ND 6-8 mm.....72
26052	Drill EV-GS, narrow diam. Sleeve, Ø1.9 ND 9-11 mm.....72
26053	Drill EV-GS, narrow diam. Sleeve, Ø1.9 ND 13-15 mm.....72
26054	Drill EV-GS, narrow diam. Sleeve, Ø2.5/3.1 ND 6-8 mm.....72
26055	Drill EV-GS, narrow diam. Sleeve, Ø2.5/3.1 ND 9-11 mm.....72
26056	Drill EV-GS, narrow diam. Sleeve, Ø2.5/3.1 ND 13-15 mm.....72
26057	Drill EV-GS, narrow diam. Sleeve, Ø3.1/3.7 ND 6-8 mm.....72
26058	Drill EV-GS, narrow diam. Sleeve, Ø3.1/3.7 ND 9-11 mm.....72
26059	Drill EV-GS, narrow diam. Sleeve, Ø3.1/3.7 ND 13-15 mm.....72
26060	Drill EV-GS, wide diam. Sleeve, Ø1.9 WD 6-8 mm.....72
26061	Drill EV-GS, wide diam. Sleeve, Ø1.9 WD 9-11 mm.....72
26062	Drill EV-GS, wide diam. Sleeve, Ø1.9 WD 13-15 mm.....72
26063	Drill EV-GS, wide diam. Sleeve, Ø2.5/3.1 WD 6-8 mm.....72
26064	Drill EV-GS, wide diam. Sleeve, Ø2.5/3.1 WD 9-11 mm.....72
26065	Drill EV-GS, wide diam. Sleeve, Ø2.5/3.1 WD 13-15 mm.....72
26066	Drill EV-GS, wide diam. Sleeve, Ø3.1/3.7 WD 6-8 mm.....72
26067	Drill EV-GS, wide diam. Sleeve, Ø3.1/3.7 WD 9-11 mm.....72
26068	Drill EV-GS, wide diam. Sleeve, Ø3.1/3.7 WD 13-15 mm.....72
26069	Drill EV-GS, wide diam. Sleeve, Ø3.7/4.3 WD 6-8 mm.....72
26070	Drill EV-GS, wide diam. Sleeve, Ø3.7/4.3 WD 9-11 mm.....72
26071	Drill EV-GS, wide diam. Sleeve, Ø3.7/4.3 WD 13-15 mm.....72
26072	X-Drill EV-GS 3.6-4.2C, Ø 3.1/3.45, 6-8 mm.....74
26073	X-Drill EV-GS 3.6-4.2C, Ø 3.1/3.45, 9-11 mm.....74
26074	X-Drill EV-GS 3.6-4.2C, Ø 3.1/3.45, 13-15 mm.....74
26075	X-Drill EV-GS 4.2, Ø 3.7/4.05, 6-8 mm.....74
26076	X-Drill EV-GS 4.2, Ø 3.7/4.05, 9-11 mm.....74
26077	X-Drill EV-GS 4.2, Ø 3.7/4.05, 13-15 mm.....74
26078	X-Drill EV-GS 4.8C, Ø 3.7/4.05, 6-8 mm.....74
26079	X-Drill EV-GS 4.8C, Ø 3.7/4.05, 9-11 mm.....74
26080	X-Drill EV-GS 4.8C, Ø 3.7/4.05, 13-15 mm.....74
26081	X-Drill EV-GS 4.8, Ø 4.3/4.65, 6-8 mm.....74
26082	X-Drill EV-GS 4.8, Ø 4.3/4.65, 9-11 mm.....74
26083	X-Drill EV-GS 4.8, Ø 4.3/4.65, 13-15 mm.....74
26084	V-Drill EV-GS 3.6-4.2C, Ø 3.1, 6-8 mm.....74
26085	V-Drill EV-GS 3.6-4.2C, Ø 3.1, 9-11 mm.....74
26086	V-Drill EV-GS 3.6-4.2C, Ø 3.1, 13-15 mm.....74
26087	V-Drill EV-GS 4.2, Ø 3.7, 6-8 mm.....74
26088	V-Drill EV-GS 4.2, Ø 3.7, 9-11 mm.....74
26089	V-Drill EV-GS 4.2, Ø 3.7, 13-15 mm.....74
26090	V-Drill EV-GS 4.8C, Ø 3.7, 6-8 mm.....74
26091	V-Drill EV-GS 4.8C, Ø 3.7, 9-11 mm.....74
26092	V-Drill EV-GS 4.8C, Ø 3.7, 13-15 mm.....74
26093	V-Drill EV-GS 4.8, Ø 4.3, 6-8 mm.....74
26094	V-Drill EV-GS 4.8, Ø 4.3, 9-11 mm.....74
26095	V-Drill EV-GS 4.8, Ø 4.3, 13-15 mm.....74
26098	Large Tray EV Proline.....69
26099	Large Tray EV Streamline.....69
26159	Multibase Abutment EV 3.6 - 1.5 mm NI.....6, 32
26160	Multibase Abutment EV 3.6 - 2.5 mm NI.....6, 32
26161	Multibase Abutment EV 3.6 - 3.5 mm NI.....6, 32

REF	page
26162	Multibase Abutment EV 3.6, 17° - 1.5 mm 6, 32
26163	Multibase Abutment EV 3.6, 17° - 2.5 mm 6, 32
26164	Multibase Abutment EV 3.6, 30° - 1.5 mm 6, 32
26165	Multibase Abutment EV 3.6, 30° - 2.5 mm 6, 32
26166	Multibase Abutment EV 3.6, 17° - 1.5 mm NI 6, 32
26167	Multibase Abutment EV 3.6, 17° - 2.5 mm NI 6, 32
26168	Multibase Abutment EV 3.6, 30° - 1.5 mm NI 6, 32
26169	Multibase Abutment EV 3.6, 30° - 2.5 mm NI 6, 32
26170	Multibase Abutment EV 4.2 - 1.5 mm NI 8, 32
26171	Multibase Abutment EV 4.2 - 2.5 mm NI 8, 32
26172	Multibase Abutment EV 4.2 - 3.5 mm NI 8, 32
26173	Multibase Abutment EV 4.2, 17° - 1.5 mm 8, 32
26174	Multibase Abutment EV 4.2, 17° - 2.5 mm 8, 32
26175	Multibase Abutment EV 4.2, 30° - 1.5 mm 8, 32
26176	Multibase Abutment EV 4.2, 30° - 2.5 mm 8, 32
26177	Multibase Abutment EV 4.2, 17° - 1.5 mm NI 8, 32
26178	Multibase Abutment EV 4.2, 17° - 2.5 mm NI 8, 32
26179	Multibase Abutment EV 4.2, 30° - 1.5 mm NI 8, 32
26180	Multibase Abutment EV 4.2, 30° - 2.5 mm NI 8, 32
26181	Multibase Abutment EV 4.8 - 1.5 mm NI 10, 33
26182	Multibase Abutment EV 4.8 - 2.5 mm NI 10, 33
26183	Multibase Abutment EV 4.8 - 3.5 mm NI 10, 33
26184	Multibase Abutment EV 4.8, 17° - 1.5 mm 10, 33
26185	Multibase Abutment EV 4.8, 17° - 2.5 mm 10, 33
26186	Multibase Abutment EV 4.8, 30° - 1.5 mm 10, 33
26187	Multibase Abutment EV 4.8, 30° - 2.5 mm 10, 33
26188	Multibase Abutment EV 4.8, 17° - 1.5 mm NI 10, 33
26189	Multibase Abutment EV 4.8, 17° - 2.5 mm NI 10, 33
26190	Multibase Abutment EV 4.8, 30° - 1.5 mm NI 10, 33
26191	Multibase Abutment EV 4.8, 30° - 2.5 mm NI 10, 33
26192	Multibase EV Abutment Head with holder 33
26193	Multibase EV Heal Cap 6, 8, 10, 34
26194	Multibase EV Transfer 7, 9, 11, 34
26195	Multibase EV Pick-up 7, 9, 11, 34
26196	Multibase EV Bridge Screw 7, 9, 11, 35
26197	Multibase EV Lab Abutment Pin, 14 mm 7, 9, 11, 35
26198	Multibase EV Lab Abutment Pin, 18 mm 7, 9, 11, 35
26199	Multibase EV Lab Abutment Pin, 22 mm 7, 9, 11, 35
26200	Multibase EV Lab Bridge Screw 7, 9, 11, 35
26201	Multibase EV Replica 7, 9, 11, 34
26202	Multibase EV Temporary Cylinder 7, 9, 11, 34
26203	Multibase EV Burnout Cylinder 7, 9, 11, 34
26204	Multibase Driver EV 33, 53, 81
26205	SmartFix® Guide 35, 42
26206	Bone Reamer EV Ø 4.0 42
26207	Bone Reamer EV Ø 4.6 42
26208	Bone Reamer EV Ø 5.2 42
26209	Bone Reamer EV Ø 5.8 42
26210	Bone Reamer EV Ø 6.4 42
26211	Bone Reamer EV Ø 7.0 42
26212	Bone Reamer Guide EV 3.0 42
26213	Bone Reamer Guide EV 3.6 42
26214	Bone Reamer Guide EV 4.2 42
26215	Bone Reamer Guide EV 4.8 42
26216	Bone Reamer Guide EV 5.4 42
26217	Overlay Bone Reamer 42
26218	Small Tray EV including overlay Bone Reamers 42
26219	Healing Uni EV 4.8 - 2 mm/Ø 4.3 10, 19, 58
26220	Healing Uni EV 4.8 - 3 mm/Ø 4.3 10, 19, 60
26221	Healing Uni EV 4.8 - 4 mm/Ø 4.3 10, 19, 60
26222	Healing Uni EV 4.8 - 6 mm/Ø 4.3 10, 19, 60
26223	Healing Uni EV 5.4 - 2 mm/Ø 4.8 12, 19
26224	Healing Uni EV 5.4 - 3 mm/Ø 4.8 12, 19
26225	Healing Uni EV 5.4 - 4 mm/Ø 4.8 12, 19
26226	Healing Uni EV 5.4 - 6 mm/Ø 4.8 12, 19
26227	Implant Pick-Up EV 3.6 Short 7, 25
26228	Implant Pick-Up EV 4.2 Short 9, 25
26229	Implant Pick-Up EV 4.8 Short 11, 25
26230	Implant Pick-Up EV 5.4 Short 13, 25
26231	Implant Pick-Up EV 3.0 Long 5, 25
26232	Implant Pick-Up EV 3.6 Long 7, 25

REF	page
26233	Implant Pick-Up EV 4.2 Long 9, 25
26234	Implant Pick-Up EV 4.8 Long 11, 25
26235	Implant Pick-Up Design EV 3.6 Short 7, 25
26236	Implant Pick-Up Design EV 4.2 Short 9, 25
26237	Implant Pick-Up Design EV 4.8 Short 11, 25
26238	Implant Pick-Up Design EV 5.4 Short 13, 25
26239	Implant Pick-Up Design EV 3.0 Long 5, 25
26240	Implant Pick-Up Design EV 3.6 Long 7, 25
26241	Implant Pick-Up Design EV 4.2 Long 9, 25
26242	Implant Pick-Up Design EV 4.8 Long 11, 25
26243	Implant Pick-Up Design EV 5.4 Long 13, 25
26244	Angled Abutment EV Pick-Up 6, 8, 10, 31, 58, 60
26245	Uni Abutment EV Pick-Up Ø 4.3 Short 4, 6, 8, 10, 12, 30, 58, 60
26246	Uni Abutment EV Pick-Up Ø 5.5 Short 4, 6, 8, 10, 12, 30, 58, 60
26247	Uni Abutment EV Pick-Up Ø 4.3 Long 4, 6, 8, 10, 12, 30, 58, 60
26248	Uni Abutment EV Pick-Up Ø 5.5 Long 4, 6, 8, 10, 12, 30, 58, 60
26249	Uni Abutment EV Transfer 5, 7, 9, 11, 13, 30, 58, 60
26250	Uni Abutment EV Temporary Cylinder 5, 7, 9, 11, 13, 30, 59, 61
26251	Temp Abutment EV 3.0 4, 21
26252	Temp Abutment EV 3.6 6, 21
26253	Temp Abutment EV 4.2 8, 21
26254	Temp Abutment EV 4.8 10, 21
26255	Temp Abutment EV 5.4 12, 21
26256	Temp Abutment Profile EV 4.2 58, 65
26257	Temp Abutment Profile EV 4.8 60, 65
26258	Implant Pick-Up Profile EV 4.2, Short 59, 67
26259	Implant Pick-Up Profile EV 4.8, Short 61, 67
26260	Implant Pick-Up Profile EV 4.2, Long 59, 67
26261	Implant Pick-Up Profile EV 4.8, Long 61, 67
26262	Implant Pick-Up Design Profile EV 4.2 59, 67
26263	Implant Pick-Up Design Profile EV 4.8 61, 67
26264	Implant 900 Set SI-923, 230 V 50
26265	Implant 900 Set SI-915, 120 V 50
26266	Motor EM-19 50
26267	Foot Control S-N2, with cord 50, 51
26268	Contra-angle W&H WS-75 50
26269	Contra-angle W&H WS-75 L G 50
26270	Handpiece W&H S-11 Straight 50
26271	Handpiece W&H S-9 Angled 50
26273	Contra-angle W&H WI-75 E/KM 50
26278	Implant 1000 Set SI-1023, 230 V, with cord 51
26279	Implant 1000 Set SI-1015, 120 V, with cord 51
26281	Implant 1000 Set SI-1023, 230 V, cordless 51
26282	Implant 1000 Set SI-1015, 120 V, cordless 51
26301	Astra Tech Implant EV 3.0 S - 8 mm OsseoSpeed® 4, 16
26302	Astra Tech Implant EV 3.0 S - 9 mm OsseoSpeed® 4, 16
26303	Astra Tech Implant EV 3.0 S - 11 mm OsseoSpeed® 4, 16
26304	Astra Tech Implant EV 3.0 S - 13 mm OsseoSpeed® 4, 16
26305	Astra Tech Implant EV 3.0 S - 15 mm OsseoSpeed® 4, 16
26310	Astra Tech Implant EV 3.6 S - 6 mm OsseoSpeed® 6, 16
26311	Astra Tech Implant EV 3.6 S - 8 mm OsseoSpeed® 6, 16
26312	Astra Tech Implant EV 3.6 S - 9 mm OsseoSpeed® 6, 16
26313	Astra Tech Implant EV 3.6 S - 11 mm OsseoSpeed® 6, 16
26314	Astra Tech Implant EV 3.6 S - 13 mm OsseoSpeed® 6, 16
26315	Astra Tech Implant EV 3.6 S - 15 mm OsseoSpeed® 6, 16
26316	Astra Tech Implant EV 3.6 S - 17 mm OsseoSpeed® 6, 16
26320	Astra Tech Implant EV 4.2 S - 6 mm OsseoSpeed® 8, 16
26321	Astra Tech Implant EV 4.2 S - 8 mm OsseoSpeed® 8, 16
26322	Astra Tech Implant EV 4.2 S - 9 mm OsseoSpeed® 8, 16
26323	Astra Tech Implant EV 4.2 S - 11 mm OsseoSpeed® 8, 16
26324	Astra Tech Implant EV 4.2 S - 13 mm OsseoSpeed® 8, 16
26325	Astra Tech Implant EV 4.2 S - 15 mm OsseoSpeed® 8, 16
26326	Astra Tech Implant EV 4.2 S - 17 mm OsseoSpeed® 8, 16
26331	Astra Tech Implant EV 4.2 C - 8 mm OsseoSpeed® 8, 16
26332	Astra Tech Implant EV 4.2 C - 9 mm OsseoSpeed® 8, 16
26333	Astra Tech Implant EV 4.2 C - 11 mm OsseoSpeed® 8, 16
26334	Astra Tech Implant EV 4.2 C - 13 mm OsseoSpeed® 8, 16
26335	Astra Tech Implant EV 4.2 C - 15 mm OsseoSpeed® 8, 16
26336	Astra Tech Implant EV 4.2 C - 17 mm OsseoSpeed® 8, 16
26340	Astra Tech Implant EV 4.8 S - 6 mm OsseoSpeed® 10, 17
26341	Astra Tech Implant EV 4.8 S - 8 mm OsseoSpeed® 10, 17

REF		page
26342	Astra Tech Implant EV 4.8 S - 9 mm OsseoSpeed*	10, 17
26343	Astra Tech Implant EV 4.8 S - 11 mm OsseoSpeed*	10, 17
26344	Astra Tech Implant EV 4.8 S - 13 mm OsseoSpeed*	10, 17
26345	Astra Tech Implant EV 4.8 S - 15 mm OsseoSpeed*	10, 17
26346	Astra Tech Implant EV 4.8 S - 17 mm OsseoSpeed*	10, 17
26351	Astra Tech Implant EV 4.8 C - 8 mm OsseoSpeed*	10, 17
26352	Astra Tech Implant EV 4.8 C - 9 mm OsseoSpeed*	10, 17
26353	Astra Tech Implant EV 4.8 C - 11 mm OsseoSpeed*	10, 17
26354	Astra Tech Implant EV 4.8 C - 13 mm OsseoSpeed*	10, 17
26355	Astra Tech Implant EV 4.8 C - 15 mm OsseoSpeed*	10, 17
26356	Astra Tech Implant EV 4.8 C - 17 mm OsseoSpeed*	10, 17
26360	Astra Tech Implant EV 5.4 S - 6 mm OsseoSpeed*	12, 17
26361	Astra Tech Implant EV 5.4 S - 8 mm OsseoSpeed*	12, 17
26362	Astra Tech Implant EV 5.4 S - 9 mm OsseoSpeed*	12, 17
26363	Astra Tech Implant EV 5.4 S - 11 mm OsseoSpeed*	12, 17
26364	Astra Tech Implant EV 5.4 S - 13 mm OsseoSpeed*	12, 17
26365	Astra Tech Implant EV 5.4 S - 15 mm OsseoSpeed*	12, 17
26371	Astra Tech Implant EV Profile 4.2 PS - 8 mm OsseoSpeed*	58, 62
26372	Astra Tech Implant EV Profile 4.2 PS - 9 mm OsseoSpeed*	58, 62
26373	Astra Tech Implant EV Profile 4.2 PS - 11 mm OsseoSpeed*	58, 62
26374	Astra Tech Implant EV Profile 4.2 PS - 13 mm OsseoSpeed*	58, 62
26375	Astra Tech Implant EV Profile 4.2 PS - 15 mm OsseoSpeed*	58, 62
26376	Astra Tech Implant EV Profile 4.2 PS - 17 mm OsseoSpeed*	58, 62
26381	Astra Tech Implant EV Profile 4.2 PC - 8 mm OsseoSpeed*	60, 62
26382	Astra Tech Implant EV Profile 4.2 PC - 9 mm OsseoSpeed*	60, 62
26383	Astra Tech Implant EV Profile 4.2 PC - 11 mm OsseoSpeed*	60, 62
26384	Astra Tech Implant EV Profile 4.2 PC - 13 mm OsseoSpeed*	60, 62
26385	Astra Tech Implant EV Profile 4.2 PC - 15 mm OsseoSpeed*	60, 62
26386	Astra Tech Implant EV Profile 4.2 PC - 17 mm OsseoSpeed*	60, 62
26392	Motor EM-19 LC	51
26393	Foot Control S-NW, cordless	51
26394	Contra-angle WS-75 L	51
26395	Handpiece S-11 L Straight	51

REF		page
26401	Astra Tech Implant EV Profile 4.8 PS - 8 mm OsseoSpeed*	58, 62
26402	Astra Tech Implant EV Profile 4.8 PS - 9 mm OsseoSpeed*	58, 62
26403	Astra Tech Implant EV Profile 4.8 PS - 11 mm OsseoSpeed*	58, 62
26404	Astra Tech Implant EV Profile 4.8 PS - 13 mm OsseoSpeed*	58, 62
26405	Astra Tech Implant EV Profile 4.8 PS -15 mm OsseoSpeed*	58, 62
26406	Astra Tech Implant EV Profile 4.8 PS - 17 mm OsseoSpeed*	58, 62
26411	Astra Tech Implant EV Profile 4.8 PC - 8 mm OsseoSpeed*	60, 62
26412	Astra Tech Implant EV Profile 4.8 PC - 9 mm OsseoSpeed*	60, 62
26413	Astra Tech Implant EV Profile 4.8 PC - 11 mm OsseoSpeed*	60, 62
26414	Astra Tech Implant EV Profile 4.8 PC - 13 mm OsseoSpeed*	60, 62
26415	Astra Tech Implant EV Profile 4.8 PC - 15 mm OsseoSpeed*	60, 62
26416	Astra Tech Implant EV Profile 4.8 PC - 17 mm OsseoSpeed*	60, 62
3102 1405	Polymerization Sleeve	34
3102 1890	Polymerization Sleeve (for US markets)	34
3107 1000	Washtray Astra Tech Implant System* EV	43
3107 1002	Washtray Sterilization Container ATIS EV	43
3107 1020	Washtray GS Astra Tech Implant System* EV	43, 70
34593	Atlantis* FLO 3.0	24
34594	Atlantis* FLO 3.6	24
34595	Atlantis* FLO 4.2	24
34596	Atlantis* FLO 4.8	24
34597	Atlantis* FLO 5.4	24
34601	Atlantis* FLO screwdriver	24
35243	Atlantis* IO FLO 3.0	24
35244	Atlantis* IO FLO 3.6	24
35245	Atlantis* IO FLO 4.2	24
35246	Atlantis* IO FLO 4.8	24
35247	Atlantis* IO FLO 5.4	24
36030	Atlantis* Angulated Screw Access Screwdriver, 18 mm	52
36031	Atlantis* Angulated Screw Access Screwdriver, 24 mm	52
36032	Atlantis* Angulated Screw Access Screwdriver, 38 mm	52

Index

Alphabetical order

REF		page
25162	1 - Twist Drill EV Ø 1.9, 6-17 mm.....	44
25163	1 - Twist Drill EV Ø 1.9, 6-13 mm.....	44
25164	2 - Step Drill EV Ø 1.9/2.5, 6-17 mm.....	44
25165	2 - Step Drill EV Ø 1.9/2.5, 6-13 mm.....	44
25168	3 - Step Drill EV Ø 2.5/3.1, 6-17 mm.....	44
25169	3 - Step Drill EV Ø 2.5/3.1, 6-13 mm.....	44
25172	4 - Step Drill EV Ø 3.1/3.7, 6-17 mm.....	44
25173	4 - Step Drill EV Ø 3.1/3.7, 6-13 mm.....	44
25176	5 - Step Drill EV Ø 3.7/4.3, 6-17 mm.....	44
25177	5 - Step Drill EV Ø 3.7/4.3, 6-13 mm.....	44
25180	6 - Step Drill EV Ø 4.3/4.9, 6-17 mm.....	44
25181	6 - Step Drill EV Ø 4.3/4.9, 6-13 mm.....	44
25487	A 6 mm - Cortical Drill EV Ø 3.1/3.3.....	45
25412	A 6 mm - Cortical Drill EV Ø 3.7/3.9.....	45
25420	A 6 mm - Cortical Drill EV Ø 4.3/4.5.....	45
25422	A 6 mm - Cortical Drill EV Ø 4.9/5.1.....	45
25423	A - Cortical Drill EV Ø 2.5/2.7.....	45
25488	A - Cortical Drill EV Ø 3.1/3.3.....	45
25490	A - Cortical Drill EV Ø 3.7/3.9.....	45
25492	A - Cortical Drill EV Ø 4.3/4.5.....	45
25431	A - Cortical Drill EV Ø 4.9/5.1.....	45
25188	A/B - Conical Drill EV Ø 3.1/4.2.....	46
25190	A/B - Conical Drill EV Ø 3.7/4.8.....	46
25792	Abutment Depth Gauge EV 3.0/3.6.....	54
25793	Abutment Depth Gauge EV 4.2/4.8.....	54
25726	Abutment Depth Gauge EV 5.4.....	54
22429	Abutment Retriever.....	81
25203	Abutment Screw EV 3.0.....	21
25204	Abutment Screw EV 3.6.....	21
25205	Abutment Screw EV 4.2.....	21, 65
25206	Abutment Screw EV 4.8.....	21, 65
25207	Abutment Screw EV 5.4.....	21
25619	Angled Abutment EV 3.6 20° - 1 mm.....	6, 31
25621	Angled Abutment EV 3.6 20° - 1 mm NI.....	6, 31
25620	Angled Abutment EV 3.6 20° - 2 mm.....	6, 31
25622	Angled Abutment EV 3.6 20° - 2 mm NI.....	6, 31
25625	Angled Abutment EV 4.2 20° - 1 mm.....	8, 31
25627	Angled Abutment EV 4.2 20° - 1 mm NI.....	8, 31
25626	Angled Abutment EV 4.2 20° - 2 mm.....	8, 31
25628	Angled Abutment EV 4.2 20° - 2 mm NI.....	8, 31
25631	Angled Abutment EV 4.8 20° - 1 mm.....	10, 31
25632	Angled Abutment EV 4.8 20° - 2 mm.....	10, 31
25633	Angled Abutment EV 4.8 20° - 1 mm NI.....	10, 31
25634	Angled Abutment EV 4.8 20° - 2 mm NI.....	10, 31
25655	Angled Abutment EV Burnout Cylinder.....	7, 9, 11, 31, 59, 61
25650	Angled Abutment EV Heal Cap.....	6, 8, 10, 31, 58, 60
26244	Angled Abutment EV Pick-Up.....	6, 8, 10, 31, 58, 60
25652	Angled Abutment EV Replica.....	7, 9, 11, 31, 59, 61
25653	Angled Abutment EV Semi-Burnout Cylinder.....	7, 9, 11, 31, 59, 61
25654	Angled Abutment EV Temporary Cylinder.....	7, 9, 11, 31, 59, 61
25890	Angled Abutment Profile EV 4.2, 20°.....	58, 66
25891	Angled Abutment Profile EV 4.2, 20°.....	58, 66
25892	Angled Abutment Profile EV 4.8, 20°.....	60, 66
25893	Angled Abutment Profile EV 4.8, 20°.....	60, 66
26301	Astra Tech Implant EV 3.0 S - 8 mm OsseoSpeed*.....	4, 16
26302	Astra Tech Implant EV 3.0 S - 9 mm OsseoSpeed*.....	4, 16
26303	Astra Tech Implant EV 3.0 S - 11 mm OsseoSpeed*.....	4, 16
26304	Astra Tech Implant EV 3.0 S - 13 mm OsseoSpeed*.....	4, 16
26305	Astra Tech Implant EV 3.0 S - 15 mm OsseoSpeed*.....	4, 16
26310	Astra Tech Implant EV 3.6 S - 6 mm OsseoSpeed*.....	4, 16
26311	Astra Tech Implant EV 3.6 S - 8 mm OsseoSpeed*.....	4, 16

REF		page
26312	Astra Tech Implant EV 3.6 S - 9 mm OsseoSpeed*.....	6, 16
26313	Astra Tech Implant EV 3.6 S - 11 mm OsseoSpeed*.....	6, 16
26314	Astra Tech Implant EV 3.6 S - 13 mm OsseoSpeed*.....	6, 16
26315	Astra Tech Implant EV 3.6 S - 15 mm OsseoSpeed*.....	6, 16
26316	Astra Tech Implant EV 3.6 S - 17 mm OsseoSpeed*.....	6, 16
26320	Astra Tech Implant EV 4.2 S - 6 mm OsseoSpeed*.....	8, 16
26321	Astra Tech Implant EV 4.2 S - 8 mm OsseoSpeed*.....	8, 16
26322	Astra Tech Implant EV 4.2 S - 9 mm OsseoSpeed*.....	8, 16
26323	Astra Tech Implant EV 4.2 S - 11 mm OsseoSpeed*.....	8, 16
26324	Astra Tech Implant EV 4.2 S - 13 mm OsseoSpeed*.....	8, 16
26325	Astra Tech Implant EV 4.2 S - 15 mm OsseoSpeed*.....	8, 16
26326	Astra Tech Implant EV 4.2 S - 17 mm OsseoSpeed*.....	8, 16
26340	Astra Tech Implant EV 4.8 S - 6 mm OsseoSpeed*.....	10, 17
26341	Astra Tech Implant EV 4.8 S - 8 mm OsseoSpeed*.....	10, 17
26342	Astra Tech Implant EV 4.8 S - 9 mm OsseoSpeed*.....	10, 17
26343	Astra Tech Implant EV 4.8 S - 11 mm OsseoSpeed*.....	10, 17
26344	Astra Tech Implant EV 4.8 S - 13 mm OsseoSpeed*.....	10, 17
26345	Astra Tech Implant EV 4.8 S - 15 mm OsseoSpeed*.....	10, 17
26346	Astra Tech Implant EV 4.8 S - 17 mm OsseoSpeed*.....	10, 17
26360	Astra Tech Implant EV 5.4 S - 6 mm OsseoSpeed*.....	12, 17
26361	Astra Tech Implant EV 5.4 S - 8 mm OsseoSpeed*.....	12, 17
26362	Astra Tech Implant EV 5.4 S - 9 mm OsseoSpeed*.....	12, 17
26363	Astra Tech Implant EV 5.4 S - 11 mm OsseoSpeed*.....	12, 17
26364	Astra Tech Implant EV 5.4 S - 13 mm OsseoSpeed*.....	12, 17
26365	Astra Tech Implant EV 5.4 S - 15 mm OsseoSpeed*.....	12, 17
26331	Astra Tech Implant EV 4.2 C - 8 mm OsseoSpeed*.....	8, 16
26332	Astra Tech Implant EV 4.2 C - 9 mm OsseoSpeed*.....	8, 16
26333	Astra Tech Implant EV 4.2 C - 11 mm OsseoSpeed*.....	8, 16
26334	Astra Tech Implant EV 4.2 C - 13 mm OsseoSpeed*.....	8, 16
26335	Astra Tech Implant EV 4.2 C - 15 mm OsseoSpeed*.....	8, 16
26336	Astra Tech Implant EV 4.2 C - 17 mm OsseoSpeed*.....	8, 16
26351	Astra Tech Implant EV 4.8 C - 8 mm OsseoSpeed*.....	10, 17
26352	Astra Tech Implant EV 4.8 C - 9 mm OsseoSpeed*.....	10, 17
26353	Astra Tech Implant EV 4.8 C - 11 mm OsseoSpeed*.....	10, 17
26354	Astra Tech Implant EV 4.8 C - 13 mm OsseoSpeed*.....	10, 17
26355	Astra Tech Implant EV 4.8 C - 15 mm OsseoSpeed*.....	10, 17
26356	Astra Tech Implant EV 4.8 C - 17 mm OsseoSpeed*.....	10, 17
26381	Astra Tech Implant EV Profile 4.2 PC - 8 mm OsseoSpeed*.....	60, 62
26382	Astra Tech Implant EV Profile 4.2 PC - 9 mm OsseoSpeed*.....	60, 62
26383	Astra Tech Implant EV Profile 4.2 PC - 11 mm OsseoSpeed*.....	60, 62
26384	Astra Tech Implant EV Profile 4.2 PC - 13 mm OsseoSpeed*.....	60, 62
26385	Astra Tech Implant EV Profile 4.2 PC - 15 mm OsseoSpeed*.....	60, 62
26386	Astra Tech Implant EV Profile 4.2 PC - 17 mm OsseoSpeed*.....	60, 62
26371	Astra Tech Implant EV Profile 4.2 PS - 8 mm OsseoSpeed*.....	58, 62
26372	Astra Tech Implant EV Profile 4.2 PS - 9 mm OsseoSpeed*.....	58, 62
26373	Astra Tech Implant EV Profile 4.2 PS - 11 mm OsseoSpeed*.....	58, 62
26374	Astra Tech Implant EV Profile 4.2 PS - 13 mm OsseoSpeed*.....	58, 62
26375	Astra Tech Implant EV Profile 4.2 PS - 15 mm OsseoSpeed*.....	58, 62
26376	Astra Tech Implant EV Profile 4.2 PS - 17 mm OsseoSpeed*.....	58, 62

REF	page
26411	Astra Tech Implant EV Profile 4.8 PC – 8 mm OsseoSpeed*.....60, 62
26412	Astra Tech Implant EV Profile 4.8 PC – 9 mm OsseoSpeed*.....60, 62
26413	Astra Tech Implant EV Profile 4.8 PC – 11 mm OsseoSpeed*.....60, 62
26414	Astra Tech Implant EV Profile 4.8 PC – 13 mm OsseoSpeed*.....60, 62
26415	Astra Tech Implant EV Profile 4.8 PC – 15 mm OsseoSpeed*.....60, 62
26416	Astra Tech Implant EV Profile 4.8 PC – 17 mm OsseoSpeed*.....60, 62
26401	Astra Tech Implant EV Profile 4.8 PS – 8 mm OsseoSpeed*.....58, 62
26402	Astra Tech Implant EV Profile 4.8 PS – 9 mm OsseoSpeed*.....58, 62
26403	Astra Tech Implant EV Profile 4.8 PS – 11 mm OsseoSpeed*.....58, 62
26404	Astra Tech Implant EV Profile 4.8 PS – 13 mm OsseoSpeed*.....58, 62
26405	Astra Tech Implant EV Profile 4.8 PS –15 mm OsseoSpeed*.....58, 62
26406	Astra Tech Implant EV Profile 4.8 PS – 17 mm OsseoSpeed*.....58, 62
36030	Atlantis® Angulated Screw Access Screwdriver, 18 mm.....52
36031	Atlantis® Angulated Screw Access Screwdriver, 24 mm.....52
36032	Atlantis® Angulated Screw Access Screwdriver, 38 mm.....52
34593	Atlantis® FLO 3.0.....24
34594	Atlantis® FLO 3.6.....24
34595	Atlantis® FLO 4.2.....24
34596	Atlantis® FLO 4.8.....24
34597	Atlantis® FLO 5.4.....24
34601	Atlantis® FLO screwdriver.....24
35243	Atlantis® IO FLO 3.0.....24
35244	Atlantis® IO FLO 3.6.....24
35245	Atlantis® IO FLO 4.2.....24
35246	Atlantis® IO FLO 4.8.....24
35247	Atlantis® IO FLO 5.4.....24
25411	B 6 mm – Cortical Drill EV Ø 3.1/3.6.....46
25419	B 6 mm – Cortical Drill EV Ø 3.7/4.2.....46
25421	B 6 mm – Cortical Drill EV Ø 4.3/4.8.....46
25424	B 6 mm – Cortical Drill EV Ø 4.9/5.4.....46
25193	B – Cortical Drill EV Ø 2.5/3.0.....45
25195	B – Cortical Drill EV Ø 3.1/3.6.....45
25197	B – Cortical Drill EV Ø 3.7/4.2.....45
25199	B – Cortical Drill EV Ø 4.3/4.8.....45
25201	B – Cortical Drill EV Ø 4.9/5.4.....45
25768	Ball Abutment Driver EV.....38, 54
25684	Ball Abutment EV 3.6 – 1 mm.....6, 37
25685	Ball Abutment EV 3.6 – 2 mm.....6, 37
25686	Ball Abutment EV 3.6 – 3 mm.....6, 37
25687	Ball Abutment EV 3.6 – 4 mm.....6, 37
25688	Ball Abutment EV 3.6 – 5 mm.....6, 37
25689	Ball Abutment EV 3.6 – 7 mm.....6, 37
25690	Ball Abutment EV 4.2 – 1 mm.....8, 37, 58
25691	Ball Abutment EV 4.2 – 2 mm.....8, 37, 58
25692	Ball Abutment EV 4.2 – 3 mm.....8, 37, 58
25693	Ball Abutment EV 4.2 – 4 mm.....8, 37, 58
25694	Ball Abutment EV 4.2 – 5 mm.....8, 37, 58
25695	Ball Abutment EV 4.2 – 7 mm.....8, 37, 58
25696	Ball Abutment EV 4.8 – 1 mm.....10, 38, 60
25697	Ball Abutment EV 4.8 – 2 mm.....10, 38, 60
25698	Ball Abutment EV 4.8 – 3 mm.....10, 38, 60
25699	Ball Abutment EV 4.8 – 4 mm.....10, 38, 60
25700	Ball Abutment EV 4.8 – 5 mm.....10, 38, 60
25701	Ball Abutment EV 4.8 – 7 mm.....10, 38, 60
25826	Ball Abutment EV Replica.....7, 9, 11, 38, 59, 61
26206	Bone Reamer EV Ø 4.0.....42
26207	Bone Reamer EV Ø 4.6.....42
26208	Bone Reamer EV Ø 5.2.....42
26209	Bone Reamer EV Ø 5.8.....42

REF	page
26210	Bone Reamer EV Ø 6.4.....42
26211	Bone Reamer EV Ø 7.0.....42
26212	Bone Reamer Guide EV 3.0.....42
26213	Bone Reamer Guide EV 3.6.....42
26214	Bone Reamer Guide EV 4.2.....42
26215	Bone Reamer Guide EV 4.8.....42
26216	Bone Reamer Guide EV 5.4.....42
22179	BoneTrap.....49
25481	Bridge Screw EV – M1.8.....5, 7, 9, 11, 13, 30, 59, 61
25326	CastDesign™ EV 3.6.....6, 23
25327	CastDesign™ EV 4.2.....8, 23
25328	CastDesign™ EV 4.8.....10, 23
25329	CastDesign™ EV 5.4.....12, 23
26001	Conical Drill EV-GS, 4.2C, Ø 3.1/4.2, 8-11-15.....72
26000	Conical Drill EV-GS, 4.2C, Ø 3.1/4.2, 9-13.....72
26003	Conical Drill EV-GS, 4.8C, Ø 3.7/4.8, 8-11-15.....72
26002	Conical Drill EV-GS, 4.8C, Ø 3.7/4.8, 9-13.....72
26394	Contra-angle WS-75 L.....51
26273	Contra-angle W&H WI-75 E/KM.....50
26268	Contra-angle W&H WS-75.....50
26269	Contra-angle W&H WS-75 L G.....50
26004	Cortical Drill EV-GS, 3.6, Ø 3.1/3.3.....73
26005	Cortical Drill EV-GS, 3.6, Ø 3.1/3.6.....73
26006	Cortical Drill EV-GS, 4.2, Ø 3.7/3.9.....73
26007	Cortical Drill EV-GS, 4.2, Ø 3.7/4.2.....73
26008	Cortical Drill EV-GS, 4.8, Ø 4.3/4.5.....73
26009	Cortical Drill EV-GS, 4.8, Ø 4.3/4.8.....73
25280	Cover Screw EV 3.0.....4, 17
25281	Cover Screw EV 3.6 – 0 mm.....6, 17
25282	Cover Screw EV 4.2 – 0 mm.....8, 17
25283	Cover Screw EV 4.8 – 0 mm.....10, 17
25284	Cover Screw EV 5.4 – 0 mm.....12, 17
25582	Cover Screw Profile EV 4.2.....58, 63
25583	Cover Screw Profile EV 4.8.....60, 63
25827	Dalbo Plus Duplicating Aid.....38
25834	Dalbo Plus Female Part TE Basic, complete.....7, 9, 11, 38, 59, 61
25844	Dalbo Plus Lamellae retention Insert E.....38
25835	Dalbo Plus Screwdriver / Activator.....38, 54
25361	Direct Abutment™ EV 3.0 Ø 3.3 – 1 mm.....5, 27
25362	Direct Abutment™ EV 3.0 Ø 3.3 – 2 mm.....5, 27
25363	Direct Abutment™ EV 3.0 Ø 3.3 – 3 mm.....5, 27
25364	Direct Abutment™ EV 3.6 Ø 4 – 1 mm.....7, 27
25365	Direct Abutment™ EV 3.6 Ø 4 – 2 mm.....7, 27
25366	Direct Abutment™ EV 3.6 Ø 4 – 3 mm.....7, 27
25367	Direct Abutment™ EV 4.2 Ø 5 – 1 mm.....9, 27, 59
25368	Direct Abutment™ EV 4.2 Ø 5 – 2 mm.....9, 27, 59
25369	Direct Abutment™ EV 4.2 Ø 5 – 3 mm.....9, 27, 59
25494	Direct Abutment™ EV 4.2 Ø 6 – 1 mm.....9, 27, 59
25495	Direct Abutment™ EV 4.2 Ø 6 – 2 mm.....9, 27, 59
25496	Direct Abutment™ EV 4.2 Ø 6 – 3 mm.....9, 27, 59
25497	Direct Abutment™ EV 4.8 Ø 6 – 1 mm.....11, 27, 61
25498	Direct Abutment™ EV 4.8 Ø 6 – 2 mm.....11, 27, 61
25499	Direct Abutment™ EV 4.8 Ø 6 – 3 mm.....11, 27, 61
25370	Direct Abutment™ EV 4.8 Ø 5 – 1 mm.....11, 27, 61
25371	Direct Abutment™ EV 4.8 Ø 5 – 2 mm.....11, 27, 61
25372	Direct Abutment™ EV 4.8 Ø 5 – 3 mm.....11, 27, 61
25373	Direct Abutment™ EV 5.4 Ø 6 – 1 mm.....13, 27
25374	Direct Abutment™ EV 5.4 Ø 6 – 2 mm.....13, 27
25375	Direct Abutment™ EV 5.4 Ø 6 – 3 mm.....13, 27
25310	Direct Abutment™ EV Heal Cap 3.3.....28
25311	Direct Abutment™ EV Heal Cap 4.....28
25312	Direct Abutment™ EV Heal Cap 5.....28
25313	Direct Abutment™ EV Heal Cap 6.....28
25396	Direct Abutment™ EV Pick-Up 3.3.....28
25397	Direct Abutment™ EV Pick-Up 4.....28
25398	Direct Abutment™ EV Pick-Up 5.....28
25399	Direct Abutment™ EV Pick-Up 6.....28
25401	Direct Abutment™ EV Replica 3.3.....28
25402	Direct Abutment™ EV Replica 4.....28
25403	Direct Abutment™ EV Replica 5.....28
25404	Direct Abutment™ EV Replica 6.....28

REF	page
25406	Direct Abutment™ EV Burnout Cap 3.3.....28
25407	Direct Abutment™ EV Burnout Cap 4.....28
25408	Direct Abutment™ EV Burnout Cap 5.....28
25409	Direct Abutment™ EV Burnout Cap 6.....28
25764	Direct Driver EV Ø3.3 Ø4.....27, 53
25346	Direct EV API™ Ø 3.3.....28
25347	Direct EV API™ Ø 4.....28
25348	Direct EV API™ Ø 5.....28, 59, 61
25349	Direct EV API™ Ø 6.....28, 59, 61
25765	Direction Indicator EV48
26051	Drill EV-GS, narrow diam. Sleeve, Ø1.9 ND 6-8 mm.....72
26052	Drill EV-GS, narrow diam. Sleeve, Ø1.9 ND 9-11 mm.....72
26053	Drill EV-GS, narrow diam. Sleeve, Ø1.9 ND 13-15 mm.....72
26054	Drill EV-GS, narrow diam. Sleeve, Ø2.5/3.1 ND 6-8 mm.....72
26055	Drill EV-GS, narrow diam. Sleeve, Ø2.5/3.1 ND 9-11 mm.....72
26056	Drill EV-GS, narrow diam. Sleeve, Ø2.5/3.1 ND 13-15 mm.....72
26057	Drill EV-GS, narrow diam. Sleeve, Ø3.1/3.7 ND 6-8 mm.....72
26058	Drill EV-GS, narrow diam. Sleeve, Ø3.1/3.7 ND 9-11 mm.....72
26059	Drill EV-GS, narrow diam. Sleeve, Ø3.1/3.7 ND 13-15 mm.....72
26060	Drill EV-GS, wide diam. Sleeve, Ø1.9 WD 6-8 mm.....72
26061	Drill EV-GS, wide diam. Sleeve, Ø1.9 WD 9-11 mm.....72
26062	Drill EV-GS, wide diam. Sleeve, Ø1.9 WD 13-15 mm.....72
26063	Drill EV-GS, wide diam. Sleeve, Ø2.5/3.1 WD 6-8 mm.....72
26064	Drill EV-GS, wide diam. Sleeve, Ø2.5/3.1 WD 9-11 mm.....72
26065	Drill EV-GS, wide diam. Sleeve, Ø2.5/3.1 WD 13-15 mm.....72
26066	Drill EV-GS, wide diam. Sleeve, Ø3.1/3.7 WD 6-8 mm.....72
26067	Drill EV-GS, wide diam. Sleeve, Ø3.1/3.7 WD 9-11 mm.....72
26068	Drill EV-GS, wide diam. Sleeve, Ø3.1/3.7 WD 13-15 mm.....72
26069	Drill EV-GS, wide diam. Sleeve, Ø3.7/4.3 WD 6-8 mm.....72
26070	Drill EV-GS, wide diam. Sleeve, Ø3.7/4.3 WD 9-11 mm.....72
26071	Drill EV-GS, wide diam. Sleeve, Ø3.7/4.3 WD 13-15 mm.....72
26050	Drill for guide fixation screw76
26040	EV-PositionAid 3.6, 6-9-13 mm.....75
26039	EV-PositionAid 3.6, 8-11-15 mm.....75
26042	EV-PositionAid 4.2, 6-9-13 mm.....75
26041	EV-PositionAid 4.2, 8-11-15 mm.....75
26044	EV-PositionAid 4.8, 6-9-13 mm.....75
26043	EV-PositionAid 4.8, 8-11-15 mm.....75
26046	EV-PositionAid Profile 4.2, 6-9-13 mm.....75
26045	EV-PositionAid Profile 4.2, 8-11-15 mm.....75
26048	EV-PositionAid Profile 4.8, 6-9-13 mm.....75
26047	EV-PositionAid Profile 4.8, 8-11-15 mm.....75
26033	EV-Stabilization Abutment 3.6, 8-11-15 mm.....76
26034	EV-Stabilization Abutment 3.6, 6-9-13 mm.....76
26035	EV-Stabilization Abutment 4.2, 8-11-15 mm.....76
26036	EV-Stabilization Abutment 4.2, 6-9-13 mm.....76
26037	EV-Stabilization Abutment 4.8, 8-11-15 mm.....76
26038	EV-Stabilization Abutment 4.8, 6-9-13 mm.....76
26267	Foot Control S-N2, with cord.....50, 51
26393	Foot Control S-NW, cordless.....51
22437	Forceps - 94 mm.....48
25858	Fragment Drill Ø 0.880
25859	Fragment Drill Ø 1.0.....80
25856	Fragment Fork M1.4/M1.6.....80
25857	Fragment Fork M1.8/M2.0.....80
22740	Grinding Handle.....55
25160	Guide Drill EV.....44
26049	Guide fixation screw76
25846	Guiding Cylinder EV 3.0.....79
25847	Guiding Cylinder EV 3.6.....79
25848	Guiding Cylinder EV 4.2, P4.2.....79
25849	Guiding Cylinder EV 4.8, P4.8.....79
25850	Guiding Cylinder EV 5.4.....79
25855	Guiding Cylinder Handle79
25851	Guiding Cylinder Uni Abutment EV.....79
26395	Handpiece S-11 L Straight.....51
26271	Handpiece W&H S-9 Angled.....50
26270	Handpiece W&H S-11 Straight.....50
25901	HealDesign™ EV 3.0, Ø 3.5 - 2.5 mm.....4, 18
25298	HealDesign™ EV 3.0, Ø 3.5 - 3.5 mm.....4, 18
25297	HealDesign™ EV 3.0, Ø 3.5 - 4.5 mm.....4, 18

REF	page
25795	HealDesign™ EV 3.0, Ø 3.5 - 6.5 mm.....4, 18
25902	HealDesign™ EV 3.6, Ø 4 - 2.5 mm.....4, 18
25300	HealDesign™ EV 3.6, Ø 4 - 3.5 mm.....6, 18
25299	HealDesign™ EV 3.6, Ø 4 - 4.5 mm.....6, 18
25903	HealDesign™ EV 3.6, Ø 4 - 5 mm.....4, 18
25796	HealDesign™ EV 3.6, Ø 4 - 6.5 mm.....6, 18
25920	HealDesign™ EV 3.6, Ø 5 - 3.5 mm.....6, 18
25301	HealDesign™ EV 3.6, Ø 5 - 3.5 mm Triangular.....6, 18
25904	HealDesign™ EV 3.6, Ø 5 - 4.5 mm.....4, 18
25905	HealDesign™ EV 3.6, Ø 5 - 6.5 mm.....4, 18
25906	HealDesign™ EV 3.6, Ø 6 - 3.5 mm.....4, 18
25907	HealDesign™ EV 3.6, Ø 6 - 4.5 mm.....4, 18
25908	HealDesign™ EV 4.2, Ø 5 - 2.5 mm.....8, 18, 58
25501	HealDesign™ EV 4.2, Ø 5 - 3.5 mm.....8, 18, 58
25303	HealDesign™ EV 4.2, Ø 5 - 3.5 mm Triangular.....8, 18
25302	HealDesign™ EV 4.2, Ø 5 - 4.5 mm.....8, 18, 58
25797	HealDesign™ EV 4.2, Ø 5 - 6.5 mm.....8, 18, 58
25304	HealDesign™ EV 4.2, Ø 6.5 - 3.5 mm Triangular.....8, 18
25909	HealDesign™ EV 4.2, Ø 6.5 - 2.5 mm.....8, 18, 58
25910	HealDesign™ EV 4.2, Ø 6.5 - 3.5 mm.....8, 18, 58
25911	HealDesign™ EV 4.2, Ø 6.5 - 4.5 mm.....8, 18, 58
25912	HealDesign™ EV 4.2, Ø 6.5 - 6.5 mm.....8, 18, 58
25913	HealDesign™ EV 4.8, Ø 5 - 2.5 mm.....10, 18, 60
25502	HealDesign™ EV 4.8, Ø 5 - 3.5 mm.....10, 18, 60
25305	HealDesign™ EV 4.8, Ø 5 - 3.5 mm Triangular.....10, 18
25914	HealDesign™ EV 4.8, Ø 5 - 4.5 mm.....10, 18, 60
25915	HealDesign™ EV 4.8, Ø 5 - 6.5 mm.....10, 18, 60
25916	HealDesign™ EV 4.8, Ø 6.5 - 2.5 mm.....10, 18, 60
25917	HealDesign™ EV 4.8, Ø 6.5 - 3.5 mm.....10, 18, 60
25307	HealDesign™ EV 4.8, Ø 6.5 - 3.5 mm Triangular.....10, 18
25306	HealDesign™ EV 4.8, Ø 6.5 - 4.5 mm.....10, 18, 60
25798	HealDesign™ EV 4.8, Ø 6.5 - 6.5 mm.....10, 18, 60
25918	HealDesign™ EV 4.8, Ø 7.5 - 3.5 mm.....10, 18, 60
25919	HealDesign™ EV 4.8, Ø 7.5 - 4.5 mm.....10, 18, 60
25921	HealDesign™ EV 5.4, Ø 6.5 - 2.5 mm.....12, 18
25309	HealDesign™ EV 5.4, Ø 6.5 - 3.5 mm.....12, 18
25308	HealDesign™ EV 5.4, Ø 6.5 - 4.5 mm.....12, 18
25799	HealDesign™ EV 5.4, Ø 6.5 - 6.5 mm.....12, 18
25922	HealDesign™ EV 5.4, Ø 7.5 - 3.5 mm.....12, 18
25923	HealDesign™ EV 5.4, Ø 7.5 - 4.5 mm.....12, 18
25584	HealDesign™ Profile EV 4.2, Ø 5.....58, 64
25587	HealDesign™ Profile EV 4.2, Ø 5.....58, 64
25585	HealDesign™ Profile EV 4.2, Ø 5 Triangular.....58, 64
25586	HealDesign™ Profile EV 4.2, Ø 6.5 Triangular.....58, 64
25591	HealDesign™ Profile EV 4.8, Ø 5.....60, 64
25588	HealDesign™ Profile EV 4.8, Ø 5 Triangular.....60, 64
25589	HealDesign™ Profile EV 4.8, Ø 6.5 Triangular.....60, 64
25590	HealDesign™ Profile EV 4.8, Ø 6.5 Triangular.....60, 64
25574	Healing Uni EV 3.0 - 2 mm.....4, 19
25575	Healing Uni EV 3.0 - 3 mm.....4, 19
25576	Healing Uni EV 3.0 - 4 mm.....4, 19
25577	Healing Uni EV 3.0 - 6 mm.....4, 19
25285	Healing Uni EV 3.6 - 2 mm/Ø 4.....6, 19
25578	Healing Uni EV 3.6 - 3 mm/Ø 4.....6, 19
25286	Healing Uni EV 3.6 - 4 mm/Ø 4.....6, 19
25287	Healing Uni EV 3.6 - 6 mm/Ø 4.....6, 19
25288	Healing Uni EV 4.2 - 2 mm/Ø 4.....8, 19, 58
25579	Healing Uni EV 4.2 - 3 mm/Ø 4.....8, 19, 58
25289	Healing Uni EV 4.2 - 4 mm/Ø 4.....8, 19, 58
25290	Healing Uni EV 4.2 - 6 mm/Ø 4.....8, 19, 58
26219	Healing Uni EV 4.8 - 2 mm/Ø 4.3.....10, 19, 58
26220	Healing Uni EV 4.8 - 3 mm/Ø 4.3.....10, 19, 60
26221	Healing Uni EV 4.8 - 4 mm/Ø 4.3.....10, 19, 60
26222	Healing Uni EV 4.8 - 6 mm/Ø 4.3.....10, 19, 60
26223	Healing Uni EV 5.4 - 2 mm/Ø 4.8.....12, 19
26224	Healing Uni EV 5.4 - 3 mm/Ø 4.8.....12, 19
26225	Healing Uni EV 5.4 - 4 mm/Ø 4.8.....12, 19
26226	Healing Uni EV 5.4 - 6 mm/Ø 4.8.....12, 19
25727	Hex Driver EV Machine Intermediate, 24 mm.....49, 52
25728	Hex Driver EV Machine Long, 35 mm.....49, 52
25790	Hex Driver EV Machine Short, 20 mm.....49, 52

REF		page
25771	Hex Driver EV Manual Short, 20 mm.....	49, 52, 82
25772	Hex Driver EV Manual Intermediate, 31 mm.....	49, 52, 82
25773	Hex Driver EV Manual Long, 38 mm.....	49, 52, 82
26264	Implant 900 Set SI-923, 230 V.....	50
26265	Implant 900 Set SI-915, 120 V.....	50
26279	Implant 1000 Set SI-1015, 120 V, with cord.....	51
26282	Implant 1000 Set SI-1015, 120 V, cordless.....	51
26278	Implant 1000 Set SI-1023, 230 V, with cord.....	51
26281	Implant 1000 Set SI-1023, 230 V, cordless.....	51
25710	Implant Depth Gauge EV.....	48
25377	Implant Driver EV 3.0 Long.....	48
25379	Implant Driver EV 3.6 Long.....	48
25378	Implant Driver EV 3.6 Short.....	48
25381	Implant Driver EV 4.2 Long.....	48
25380	Implant Driver EV 4.2 Short.....	48
25383	Implant Driver EV 4.8 Long.....	48
25382	Implant Driver EV 4.8 Short.....	48
25385	Implant Driver EV 5.4 Long.....	48
25384	Implant Driver EV 5.4 Short.....	48
26016	Implant Driver EV-GS 3.6.....	75
26017	Implant Driver EV-GS 4.2.....	75
26018	Implant Driver EV-GS 4.8.....	75
26019	Implant Driver EV-GS Profile 4.2.....	75
26020	Implant Driver EV-GS Profile 4.8.....	75
26021	Implant Driver Extender EV-GS.....	48, 75
25464	Implant Driver Profile EV 4.2 Short.....	63
25465	Implant Driver Profile EV 4.2 Long.....	63
25466	Implant Driver Profile EV 4.8 Short.....	63
25467	Implant Driver Profile EV 4.8 Long.....	63
26239	Implant Pick-Up Design EV 3.0 Long.....	5, 25
26240	Implant Pick-Up Design EV 3.6 Long.....	7, 25
26235	Implant Pick-Up Design EV 3.6 Short.....	7, 25
26241	Implant Pick-Up Design EV 4.2 Long.....	9, 25
26236	Implant Pick-Up Design EV 4.2 Short.....	9, 25
26242	Implant Pick-Up Design EV 4.8 Long.....	11, 25
26237	Implant Pick-Up Design EV 4.8 Short.....	11, 25
26243	Implant Pick-Up Design EV 5.4 Long.....	13, 25
26238	Implant Pick-Up Design EV 5.4 Short.....	13, 25
26262	Implant Pick-Up Design Profile EV 4.2.....	59, 67
26263	Implant Pick-Up Design Profile EV 4.8.....	61, 67
26231	Implant Pick-Up EV 3.0 Long.....	5, 25
26232	Implant Pick-Up EV 3.6 Long.....	7, 25
26227	Implant Pick-Up EV 3.6 Short.....	7, 25
26233	Implant Pick-Up EV 4.2 Long.....	9, 25
26228	Implant Pick-Up EV 4.2 Short.....	9, 25
26234	Implant Pick-Up EV 4.8 Long.....	11, 25
26229	Implant Pick-Up EV 4.8 Short.....	11, 25
26230	Implant Pick-Up EV 5.4 Short.....	13, 25
26260	Implant Pick-Up Profile EV 4.2, Long.....	59, 67
26258	Implant Pick-Up Profile EV 4.2, Short.....	59, 67
26261	Implant Pick-Up Profile EV 4.8, Long.....	61, 67
26259	Implant Pick-Up Profile EV 4.8, Short.....	61, 67
25543	Implant Replica EV 3.0.....	5, 26
25544	Implant Replica EV 3.6.....	7, 26
25545	Implant Replica EV 4.2.....	9, 26
25546	Implant Replica EV 4.8.....	11, 26
25547	Implant Replica EV 5.4.....	13, 26
25610	Implant Replica Profile EV 4.2.....	59, 67
25611	Implant Replica Profile EV 4.8.....	61, 67
22192	Implant Retriever.....	81
25534	Implant Transfer EV 3.0 Long.....	5, 26
25536	Implant Transfer EV 3.6 Long.....	7, 26
25535	Implant Transfer EV 3.6 Short.....	7, 26
25538	Implant Transfer EV 4.2 Long.....	9, 26
25537	Implant Transfer EV 4.2 Short.....	9, 26
25540	Implant Transfer EV 4.8 Long.....	11, 26
25539	Implant Transfer EV 4.8 Short.....	11, 26
25542	Implant Transfer EV 5.4 Long.....	13, 26
25541	Implant Transfer EV 5.4 Short.....	13, 26
25607	Implant Transfer Profile EV 4.2, Long.....	59, 67
25606	Implant Transfer Profile EV 4.2, Short.....	59, 67

REF		page
25609	Implant Transfer Profile EV 4.8, Long.....	61, 67
25608	Implant Transfer Profile EV 4.8, Short.....	61, 67
26013	Initial Drill Ø 3.6.....	71
26014	Initial Drill Ø 4.2.....	71
26015	Initial Drill Ø 4.8.....	71
24785	Irrigation Set.....	50, 51
25644	Lab Abutment Pin EV Intermediate.....	5, 7, 9, 11, 13, 30, 55, 59, 61
25645	Lab Abutment Pin EV Long.....	5, 7, 9, 11, 13, 30, 55, 59, 61
25643	Lab Abutment Pin EV Short.....	5, 7, 9, 11, 13, 30, 55, 59, 61
25476	Lab Abutment Screw EV 3.0.....	5, 26, 55
25477	Lab Abutment Screw EV 3.6 - M1.6.....	7, 26, 55
25478	Lab Abutment Screw EV 4.2 - M1.8.....	9, 26, 55, 59, 67
25479	Lab Abutment Screw EV 4.8 - M2.....	11, 26, 55, 61, 67
25480	Lab Abutment Screw EV 5.4 - M2.....	13, 26, 55
25656	Lab Bridge Screw EV - M1.8.....	5, 7, 9, 11, 13, 30, 55, 59, 61
25528	Lab Pin Design EV 3.0/3.6.....	5, 7, 26, 55
25530	Lab Pin Design EV 4.2/4.8/5.4.....	9, 11, 13, 26, 55, 59, 61
25769	Large Tray EV.....	40, 69
25721	Large Tray EV, Overlay 1.....	40
25722	Large Tray EV, Overlay 2.....	40
25723	Large Tray EV, Overlay 3.....	40
26098	Large Tray EV Proline.....	69
26099	Large Tray EV Streamline.....	69
25657	Locator™ Abutment EV 3.6 - 1 mm.....	6, 36
25658	Locator™ Abutment EV 3.6 - 2 mm.....	6, 36
25659	Locator™ Abutment EV 3.6 - 3 mm.....	6, 36
25660	Locator™ Abutment EV 3.6 - 4 mm.....	6, 36
25661	Locator™ Abutment EV 3.6 - 5 mm.....	6, 36
25662	Locator™ Abutment EV 4.2 - 1 mm.....	8, 36, 58
25663	Locator™ Abutment EV 4.2 - 2 mm.....	8, 36, 58
25664	Locator™ Abutment EV 4.2 - 3 mm.....	8, 36, 58
25665	Locator™ Abutment EV 4.2 - 4 mm.....	8, 36, 58
25666	Locator™ Abutment EV 4.2 - 5 mm.....	8, 36, 58
25667	Locator™ Abutment EV 4.8 - 1 mm.....	10, 36, 60
25668	Locator™ Abutment EV 4.8 - 2 mm.....	10, 36, 60
25669	Locator™ Abutment EV 4.8 - 3 mm.....	10, 36, 60
25670	Locator™ Abutment EV 4.8 - 4 mm.....	10, 36, 60
25671	Locator™ Abutment EV 4.8 - 5 mm.....	10, 36, 60
24484	Locator™ Abutment Pick-up.....	6, 8, 10, 36, 58, 60
24485	Locator™ Abutment Replica.....	7, 9, 11, 36, 59, 61
24482	Locator™ Core Tool.....	36, 54
25766	Locator™ Driver EV.....	32, 53
24488	Locator™ Insert Blue.....	7, 9, 11, 37, 59, 61
24486	Locator™ Insert Clear.....	7, 9, 11, 37, 59, 61
24489	Locator™ Insert Green.....	7, 9, 11, 37, 59, 61
25679	Locator™ Insert Grey.....	7, 9, 11, 37, 59, 61
25843	Locator™ Insert Orange.....	7, 9, 11, 37, 59, 61
24487	Locator™ Insert Pink.....	7, 9, 11, 37, 59, 61
24492	Locator™ Insert Red.....	7, 9, 11, 37, 59, 61
24483	Locator™ Process Kit.....	7, 9, 11, 37, 59, 61
26266	Motor EM-19.....	50
26392	Motor EM-19 LC.....	51
25711	Mucosal Punch EV Ø 3.5.....	49
25712	Mucosal Punch EV Ø 4.....	49
25713	Mucosal Punch EV Ø 4.5.....	49
25714	Mucosal Punch EV Ø 5.....	49
25715	Mucosal Punch EV Ø 5.5.....	49
25731	Mucosal Punch EV Ø 6.5.....	49
26159	Multibase Abutment EV 3.6 - 1.5 mm NI.....	6, 32
26160	Multibase Abutment EV 3.6 - 2.5 mm NI.....	6, 32
26161	Multibase Abutment EV 3.6 - 3.5 mm NI.....	6, 32
26162	Multibase Abutment EV 3.6, 17° - 1.5 mm.....	6, 32
26163	Multibase Abutment EV 3.6, 17° - 2.5 mm.....	6, 32
26164	Multibase Abutment EV 3.6, 30° - 1.5 mm.....	6, 32
26165	Multibase Abutment EV 3.6, 30° - 2.5 mm.....	6, 32
26166	Multibase Abutment EV 3.6, 17° - 1.5 mm NI.....	6, 32
26167	Multibase Abutment EV 3.6, 17° - 2.5 mm NI.....	6, 32
26168	Multibase Abutment EV 3.6, 30° - 1.5 mm NI.....	6, 32
26169	Multibase Abutment EV 3.6, 30° - 2.5 mm NI.....	6, 32
26170	Multibase Abutment EV 4.2 - 1.5 mm NI.....	8, 32
26171	Multibase Abutment EV 4.2 - 2.5 mm NI.....	8, 32

REF	page
26172	Multibase Abutment EV 4.2 - 3.5 mm NI.....8, 32
26173	Multibase Abutment EV 4.2, 17° - 1.5 mm.....8, 32
26174	Multibase Abutment EV 4.2, 17° - 2.5 mm.....8, 32
26175	Multibase Abutment EV 4.2, 30° - 1.5 mm.....8, 32
26176	Multibase Abutment EV 4.2, 30° - 2.5 mm.....8, 32
26177	Multibase Abutment EV 4.2, 17° - 1.5 mm NI.....8, 32
26178	Multibase Abutment EV 4.2, 17° - 2.5 mm NI.....8, 32
26179	Multibase Abutment EV 4.2, 30° - 1.5 mm NI.....8, 32
26180	Multibase Abutment EV 4.2, 30° - 2.5 mm NI.....8, 32
26181	Multibase Abutment EV 4.8 - 1.5 mm NI.....10, 33
26182	Multibase Abutment EV 4.8 - 2.5 mm NI.....10, 33
26183	Multibase Abutment EV 4.8 - 3.5 mm NI.....10, 33
26184	Multibase Abutment EV 4.8, 17° - 1.5 mm.....10, 33
26185	Multibase Abutment EV 4.8, 17° - 2.5 mm.....10, 33
26186	Multibase Abutment EV 4.8, 30° - 1.5 mm.....10, 33
26187	Multibase Abutment EV 4.8, 30° - 2.5 mm.....10, 33
26188	Multibase Abutment EV 4.8, 17° - 1.5 mm NI.....10, 33
26189	Multibase Abutment EV 4.8, 17° - 2.5 mm NI.....10, 33
26190	Multibase Abutment EV 4.8, 30° - 1.5 mm NI.....10, 33
26191	Multibase Abutment EV 4.8, 30° - 2.5 mm NI.....10, 33
26204	Multibase Driver EV33, 53, 81
26192	Multibase EV Abutment Head with holder.....33
26196	Multibase EV Bridge Screw.....7, 9, 11, 35
26203	Multibase EV Burnout Cylinder.....7, 9, 11, 34
26193	Multibase EV Heal Cap.....6, 8, 10, 34
26197	Multibase EV Lab Abutment Pin, 14 mm.....7, 9, 11, 35
26198	Multibase EV Lab Abutment Pin, 18 mm.....7, 9, 11, 35
26199	Multibase EV Lab Abutment Pin, 22 mm.....7, 9, 11, 35
26200	Multibase EV Lab Bridge Screw.....7, 9, 11, 35
26195	Multibase EV Pick-up.....7, 9, 11, 34
26201	Multibase EV Replica.....7, 9, 11, 34
26202	Multibase EV Temporary Cylinder.....7, 9, 11, 34
26194	Multibase EV Transfer.....7, 9, 11, 34
25638	OD Cylinder EV7, 9, 11, 38, 59, 61
26217	Overlay Bone Reamer.....42
25778	Polishing Protector Uni EV.....55
3102 1405	Polymerization Sleeve.....34
3102 1890	Polymerization Sleeve (for US markets).....34
25161	Precision Drill EV.....44
26010	Punch EV-GS Ø 3.6.....71
26011	Punch EV-GS Ø 4.2.....71
26012	Punch EV-GS Ø 4.8.....71
25500	Radiographic Implant Guides EV.....49
25637	Radiographic Implant Guides Profile EV.....63
25794	Rescue Driver Uni Abutment EV.....81
25860	Screw Extractor 0.8.....80
25861	Screw Extractor 1.0.....80
26022	Sleeve-on-Drill™ 1-Sleeve Ø1.9 ND.....76
26027	Sleeve-on-Drill™ 1-Sleeve Ø1.9 WD.....76
26028	Sleeve-on-Drill™ 3-Sleeve Ø3.1 WD.....76
26023	Sleeve-on-Drill™ 3/V-Sleeve Ø3.1 ND.....76
26024	Sleeve-on-Drill™ 4/V-Sleeve Ø3.7 ND.....76
26029	Sleeve-on-Drill™ 4/V-Sleeve Ø3.7 WD.....76
26030	Sleeve-on-Drill™ 5/V-Sleeve Ø4.3 WD.....76
26025	Sleeve-on-Drill™ X-Sleeve Ø3.45 ND.....76
26026	Sleeve-on-Drill™ X-Sleeve Ø4.05 ND.....76
26031	Sleeve-on-Drill™ X-Sleeve Ø4.05 WD.....76
26032	Sleeve-on-Drill™ X-Sleeve Ø4.65 WD.....76
25770	Small Tray EV (no overlay).....41
25724	Small Tray EV, Overlay Restorative.....41
25845	Small Tray EV, Overlay Storage.....41
25725	Small Tray EV, Overlay Surgical.....41
26218	Small Tray EV including overlay Bone Reamers.....42
25982	Small Tray EV including overlay Restorative.....41
25983	Small Tray EV including overlay Surgical.....41
25984	Small Tray EV including overlay Storage.....41
26205	SmartFix® Guide.....35, 42
26251	Temp Abutment EV 3.0.....4, 21
26252	Temp Abutment EV 3.6.....6, 21
26253	Temp Abutment EV 4.2.....8, 21
26254	Temp Abutment EV 4.8.....10, 21

REF	page
26255	Temp Abutment EV 5.4.....12, 21
26256	Temp Abutment Profile EV 4.2.....58, 65
26257	Temp Abutment Profile EV 4.8.....60, 65
25503	TempDesign™ EV 3.0.....4, 21
25504	TempDesign™ EV 3.6.....6, 21
25505	TempDesign™ EV 4.2.....8, 21
25506	TempDesign™ EV 4.8.....10, 21
25507	TempDesign™ EV 5.4.....12, 21
25756	TempDesign™ Profile EV 4.2.....58, 65
25757	TempDesign™ Profile EV 4.8.....60, 65
25862	Thread Cleaner M1.4.....80
25863	Thread Cleaner M1.6.....80
25864	Thread Cleaner M1.8.....80
25865	Thread Cleaner M2.0.....80
25330	TiDesign™ EV 3.0 Ø 4 - 2.5 mm.....4, 22
25331	TiDesign™ EV 3.0 Ø 4 - 1.5 mm.....4, 22
25332	TiDesign™ EV 3.0 15° Ø 4 - 1.5 mm.....4, 22
25333	TiDesign™ EV 3.6 Ø 5.5 - 1.5/2.5 mm Triangular.....6, 22
25334	TiDesign™ EV 3.6 Ø 4.5 - 2.5/3.5 mm.....6, 22
25335	TiDesign™ EV 3.6 20° Ø 4.5 - 1.5/2.5 mm.....6, 22
25336	TiDesign™ EV 4.2 Ø 5.5 - 1.5/2.5 mm Triangular.....8, 22
25337	TiDesign™ EV 4.2 Ø 7 - 1.5/2.5 mm Triangular.....8, 22
25338	TiDesign™ EV 4.2 Ø 5.5 - 2.5/3.5 mm.....8, 22
25339	TiDesign™ EV 4.2 20° Ø 5.5 - 1.5/2.5 mm.....8, 22
25340	TiDesign™ EV 4.8 Ø 5.5 - 1.5/2.5 mm Triangular.....10, 22
25341	TiDesign™ EV 4.8 Ø 7 - 1.5/2.5 mm Triangular.....10, 22
25342	TiDesign™ EV 4.8 Ø 7 - 2.5/3.5 mm.....10, 22
25343	TiDesign™ EV 4.8 20° Ø 5.5 - 1.5/2.5 mm.....10, 22
25344	TiDesign™ EV 5.4 Ø 7 - 2.5/3.5 mm.....12, 22
25345	TiDesign™ EV 5.4 Ø 7 - 1.5/2.5 mm.....12, 22
25594	TiDesign™ Profile EV 4.2, Ø 5.5.....58, 66
25595	TiDesign™ Profile EV 4.2, Ø 5.5 15°.....58, 66
25592	TiDesign™ Profile EV 4.2, Ø 5.5 Triangular.....58, 66
25593	TiDesign™ Profile EV 4.2, Ø 7.0 Triangular.....58, 66
25599	TiDesign™ Profile EV 4.8, Ø 5.5 15°.....60, 66
25596	TiDesign™ Profile EV 4.8, Ø 5.5 Triangular.....60, 66
25598	TiDesign™ Profile EV 4.8, Ø 7.0.....60, 66
25597	TiDesign™ Profile EV 4.8, Ø 7.0 Triangular.....60, 66
25924	TitaniumBase EV 3.0 Ø 4 - 5 mm.....5, 24
25925	TitaniumBase EV 3.0 Ø 4 - 6 mm.....5, 24
25926	TitaniumBase EV 3.6 Ø 4.1 - 5 mm.....7, 24
25927	TitaniumBase EV 3.6 Ø 4.1 - 6 mm.....7, 24
25928	TitaniumBase EV 4.2 Ø 4.7 - 5 mm.....9, 24
25929	TitaniumBase EV 4.2 Ø 4.7 - 6 mm.....9, 24
25930	TitaniumBase EV 4.8 Ø 5 - 5 mm.....11, 24
25931	TitaniumBase EV 4.8 Ø 5 - 6 mm.....11, 24
25932	TitaniumBase EV 4.8 Ø 5.5 - 5 mm.....13, 24
25933	TitaniumBase EV 4.8 Ø 5.5 - 6 mm.....13, 24
22137	Titanium Bowl.....48
25774	Torque Wrench EV49, 54, 82
25776	Torque Wrench EV Restorative Driver Handle.....54, 82
25730	Torque Wrench EV Restorative Driver Handle 4x4 Low.....54, 82
25777	Torque Wrench EV Restorative Driver Handle Low.....54, 82
25775	Torque Wrench EV Surgical Driver Handle.....49, 82
25866	Trephine Drill 3.0, 6-17 mm81
25867	Trephine Drill 3.6, 6-17 mm81
25886	Trephine Drill 4.2, P4.2, 6-13 mm81
25868	Trephine Drill 4.2, P4.2, 6-17 mm81
25887	Trephine Drill 4.8, P4.8, 6-13 mm81
25869	Trephine Drill 4.8, P4.8, 6-17 mm81
25870	Trephine Drill 5.4, 6-17 mm81
25888	Trephine Drill 5.4, 6-13 mm81
24786	Tubing Extension with Luer.....50, 51
24787	Tubing Cover Sleeve.....50, 51
25555	Uni Abutment EV 3.0 - 2 mm.....4, 29
25556	Uni Abutment EV 3.0 - 3 mm.....4, 29
25557	Uni Abutment EV 3.0 - 5 mm.....4, 29
25558	Uni Abutment EV 3.6 - 1 mm.....6, 29
25559	Uni Abutment EV 3.6 - 2 mm.....6, 29
25560	Uni Abutment EV 3.6 - 3 mm.....6, 29
25561	Uni Abutment EV 3.6 - 5 mm.....6, 29

REF	page
25562	Uni Abutment EV 4.2 - 1 mm.....8, 29, 58
25563	Uni Abutment EV 4.2 - 2 mm.....8, 29, 58
25564	Uni Abutment EV 4.2 - 3 mm.....8, 29, 58
25565	Uni Abutment EV 4.2 - 5 mm.....8, 29, 58
25566	Uni Abutment EV 4.8 - 1 mm.....10, 29, 60
25567	Uni Abutment EV 4.8 - 2 mm.....10, 29, 60
25568	Uni Abutment EV 4.8 - 3 mm.....10, 29, 60
25569	Uni Abutment EV 4.8 - 5 mm.....10, 29, 60
25570	Uni Abutment EV 5.4 - 1 mm.....12, 29
25571	Uni Abutment EV 5.4 - 2 mm.....12, 29
25572	Uni Abutment EV 5.4 - 3 mm.....12, 29
25573	Uni Abutment EV 5.4 - 5 mm.....12, 29
25649	Uni Abutment EV Burnout Cylinder5, 7, 9, 11, 13, 30, 59, 61
25952	Uni Abutment EV Heal Cap Short Ø 4.3 - 3.4 mm4, 6, 8, 10, 12, 30, 58, 60
25616	Uni Abutment EV Heal Cap Ø 4.3 - 4.4 mm4, 6, 8, 10, 12, 30, 58, 60
25953	Uni Abutment EV Heal Cap Short Ø 5.5 - 3.4 mm4, 6, 8, 10, 12, 30, 58, 60
25617	Uni Abutment EV Heal Cap Ø 5.5 - 4.4 mm4, 6, 8, 10, 12, 30, 58, 60
26245	Uni Abutment EV Pick-Up Ø 4.3 Short4, 6, 8, 10, 12, 30, 58, 60
26246	Uni Abutment EV Pick-Up Ø 5.5 Short4, 6, 8, 10, 12, 30, 58, 60
26247	Uni Abutment EV Pick-Up Ø 4.3 Long4, 6, 8, 10, 12, 30, 58, 60
26248	Uni Abutment EV Pick-Up Ø 5.5 Long4, 6, 8, 10, 12, 30, 58, 60
25615	Uni Abutment EV Replica5, 7, 9, 11, 13, 30, 59, 61
25647	Uni Abutment EV Semi-Burnout Cylinder5, 7, 9, 11, 13, 30, 59, 61
26250	Uni Abutment EV Temporary Cylinder5, 7, 9, 11, 13, 30, 59, 61
26249	Uni Abutment EV Transfer.....5, 7, 9, 11, 13, 30, 58, 60
25708	Uni Driver EV29, 53
3107 1000	Washtray Astra Tech Implant System® EV43
3107 1020	Washtray GS Astra Tech Implant System® EV43, 70
3107 1002	Washtray Sterilization Container ATIS EV43
26084	V-Drill EV-GS 3.6-4.2C, Ø 3.1, 6-8 mm.....74
26085	V-Drill EV-GS 3.6-4.2C, Ø 3.1, 9-11 mm.....74
26086	V-Drill EV-GS 3.6-4.2C, Ø 3.1, 13-15 mm.....74
26087	V-Drill EV-GS 4.2, Ø 3.7, 6-8 mm.....74
26088	V-Drill EV-GS 4.2, Ø 3.7, 9-11 mm.....74
26089	V-Drill EV-GS 4.2, Ø 3.7, 13-15 mm.....74
26090	V-Drill EV-GS 4.8C, Ø 3.7, 6-8 mm.....74
26091	V-Drill EV-GS 4.8C, Ø 3.7, 9-11 mm.....74
26092	V-Drill EV-GS 4.8C, Ø 3.7, 13-15 mm.....74
26093	V-Drill EV-GS 4.8, Ø 4.3, 6-8 mm.....74
26094	V-Drill EV-GS 4.8, Ø 4.3, 9-11 mm74

REF	page
26095	V-Drill EV-GS 4.8, Ø 4.3, 13-15 mm.....74
25985	V - Twist Drill EV Ø 2.5, 6-13 mm.....47
25780	V - Twist Drill EV Ø 2.5, 6-17 mm.....47
25986	V - Twist Drill EV Ø 3.1, 6-13 mm.....47
25781	V - Twist Drill EV Ø 3.1, 6-17 mm.....47
25987	V - Twist Drill EV Ø 3.7, 6-13 mm47
25782	V - Twist Drill EV Ø 3.7, 6-17 mm.....47
25988	V - Twist Drill EV Ø 4.3, 6-13 mm.....47
25783	V - Twist Drill EV Ø 4.3, 6-17 mm.....47
25989	V - Twist Drill EV Ø 4.9, 6-13 mm.....47
25784	V - Twist Drill EV Ø 4.9, 6-17 mm.....47
26072	X-Drill EV-GS 3.6-4.2C, Ø 3.1/3.45, 6-8 mm74
26073	X-Drill EV-GS 3.6-4.2C, Ø 3.1/3.45, 9-11 mm.....74
26074	X-Drill EV-GS 3.6-4.2C, Ø 3.1/3.45, 13-15 mm.....74
26075	X-Drill EV-GS 4.2, Ø 3.7/4.05, 6-8 mm.....74
26076	X-Drill EV-GS 4.2, Ø 3.7/4.05, 9-11 mm.....74
26077	X-Drill EV-GS 4.2, Ø 3.7/4.05, 13-15 mm.....74
26078	X-Drill EV-GS 4.8C, Ø 3.7/4.05, 6-8 mm.....74
26079	X-Drill EV-GS 4.8C, Ø 3.7/4.05, 9-11 mm.....74
26080	X-Drill EV-GS 4.8C, Ø 3.7/4.05, 13-15 mm.....74
26081	X-Drill EV-GS 4.8, Ø 4.3/4.65, 6-8 mm.....74
26082	X-Drill EV-GS 4.8, Ø 4.3/4.65, 9-11 mm74
26083	X-Drill EV-GS 4.8, Ø 4.3/4.65, 13-15 mm.....74
25482	X - Step Drill EV Ø 2.5/2.85, 6-13 mm.....47
25990	X - Step Drill EV Ø 2.5/2.85, 6-17 mm.....47
25483	X - Step Drill EV Ø 3.1/3.45, 6-13 mm.....47
25991	X - Step Drill EV Ø 3.1/3.45, 6-17 mm.....47
25484	X - Step Drill EV Ø 3.7/4.05, 6-13 mm.....47
25992	X - Step Drill EV Ø 3.7/4.05, 6-17 mm.....47
25485	X - Step Drill EV Ø 4.3/4.65, 6-13 mm.....47
25993	X - Step Drill EV Ø 4.3/4.65, 6-17 mm.....47
25486	X - Step Drill EV Ø 4.9/5.25, 6-13 mm.....47
25994	X - Step Drill EV Ø 4.9/5.25, 6-17 mm.....47
25316	ZirDesign™ EV 3.6 Ø 4.5 - 2.5 mm.....6, 23
25315	ZirDesign™ EV 3.6 Ø 5.5 - 1.5 mm Triangular.....6, 23
25317	ZirDesign™ EV 3.6 20° Ø 4.5 - 1.5 mm.....6, 23
25318	ZirDesign™ EV 4.2 Ø 5.5 - 1.5 mm Triangular.....8, 23
25320	ZirDesign™ EV 4.2 Ø 5.5 - 2.5 mm.....8, 23
25319	ZirDesign™ EV 4.2 Ø 7 - 1.5 mm Triangular.....8, 23
25321	ZirDesign™ EV 4.2 20° Ø 5.5 - 1.5 mm.....8, 23
25322	ZirDesign™ EV 4.8 Ø 5.5 - 1.5 mm Triangular.....10, 23
25323	ZirDesign™ EV 4.8 Ø 7 - 1.5 mm Triangular.....10, 23
25324	ZirDesign™ EV 4.8 Ø 7 - 2.5 mm.....10, 23
25325	ZirDesign™ EV 4.8 20° Ø 5.5 - 1.5 mm.....10, 23

About Dentsply Sirona Implants

Dentsply Sirona Implants offers comprehensive solutions for all phases of implant therapy, including Ankylos®, Astra Tech Implant System® and Xive® implant lines, digital technologies, such as Atlantis® patient-specific solutions and Simplant® guided surgery, Symbios® regenerative solutions, and professional and business development programs, such as STEPPS™. Dentsply Sirona Implants creates value for dental professionals and allows for predictable and lasting implant treatment outcomes, resulting in enhanced quality of life for patients.

About Dentsply Sirona

Dentsply Sirona is the world's largest manufacturer of professional dental products and technologies, with a 130-year history of innovation and service to the dental industry and patients worldwide. Dentsply Sirona develops, manufactures, and markets a comprehensive solutions offering including dental and oral health products as well as other consumable medical devices under a strong portfolio of world class brands. As The Dental Solutions Company™, Dentsply Sirona's products provide innovative, high-quality and effective solutions to advance patient care and deliver better, safer and faster dentistry. Dentsply Sirona's global headquarters is located in York, Pennsylvania, and the international headquarters is based in Salzburg, Austria. The company's shares are listed in the United States on NASDAQ under the symbol XRAY.

Visit www.dentsplysirona.com for more information about Dentsply Sirona and its products.