

Astra Tech Implant System®

Surgical manual

Astra Tech Implant System® EV



Simplicity without compromise

The design philosophy of the Astra Tech Implant System EV is based on the natural dentition. This site-specific, crown-down approach is supported by an intuitive surgical protocol and a simple prosthetic workflow, providing an increased confidence and satisfaction for all members of the treatment team.

- Versatile implant designs, including straight, conical, sloped, short, narrow and wide, using only one surgical tray
- Flexible drilling protocol allows for preferred primary stability
- Restorative components including round and triangular options supporting soft tissue sculpturing
- Unique interface with one-position-only placement for:
 - Atlantis patient-specific abutments
 - Self-guiding impression components that require only one hand for precise seating

The foundation for Astra Tech Implant System EV is the unique Astra Tech Implant System BioManagement Complex, well-documented for its long-term marginal bone maintenance and esthetic results.

Astra Tech Implant System®

CONTENTS

Introduction – Astra Tech Implant System® EV

| | |
|---|---|
| Drilling protocol and bone classification | 4 |
| Implant assortment | 4 |
| Implant size/tooth position | 5 |
| Interface connection | 5 |
| Tray concept | 6 |
| Product identification | 8 |

Treatment planning

| | |
|--------------------------------|----|
| Pre-operative procedures | 9 |
| Clinical application | 10 |

Implant site preparation

| | |
|--|----|
| Surgical components and instruments overview | 12 |
| Implant packaging and handling | 16 |
| Drilling protocol | 18 |
| Expanded drilling protocol | 20 |
| Step-by-step implant placement | 21 |
| One-stage surgical protocol | 25 |
| Two-stage surgical protocol | 26 |

| | |
|--|----|
| Torque Wrench – surgical handling | 27 |
|--|----|

| | |
|--|----|
| Cleaning and sterilization instructions | 28 |
|--|----|

| | |
|---------------------------|----|
| Torque guide | 29 |
|---------------------------|----|

| | |
|--|----|
| Explanation of the symbols on labels and instructions for use | 29 |
|--|----|

| | |
|--|----|
| Detailed overview on the drilling protocol for OsseoSpeed® EV | 30 |
|--|----|

This manual is designed for use by clinicians who have undergone at least basic surgical and in-clinic implant training. Staying current on the latest trends and treatment techniques in implant dentistry through continued education is the responsibility of the clinician.

All products may not be regulatory cleared/released/licensed in all markets. Please, contact the local Dentsply Sirona sales office for current product assortment and availability.

To improve readability for our customers, Dentsply Sirona does not use ® or ™ in body copy. However, Dentsply Sirona does not waive any right to the trademark and nothing herein shall be interpreted to the contrary.

Product illustrations are not to scale.

Drilling protocol

The density and orientation of trabeculae in spongy bone differ between patients and sites and can give differences in resistance and perceived primary stability when installing the implant.

The marginal cortical bone is most often homogenous in quality but may vary in thickness which requires an adapted preparation.

The flexible drilling protocol is designed to allow for preferred primary implant stability in different bone qualities enabling both straight and stepped osteotomies. The stepped osteotomy provides apical bone contact when indicated for increased primary stability.

- In soft bone it may be indicated with a stepped osteotomy i.e. providing apical bone contact when increased primary stability is desired.
- In medium bone, i.e. the majority of clinical situations, apical bone contact is not indicated and therefore the step in the osteotomy can be removed by widening the apical portion with the (V)-drill.
- In dense bone the entire osteotomy is widened by using the (X)-drill.

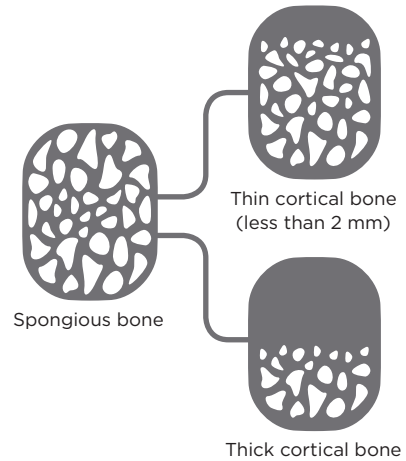

Implant assortment

OsseoSpeed EV implants are available in a versatile range of shapes, diameters and lengths for all indications, including situations with limited space and/or bone quantity.

Specific colors have been assigned to the different implant-abutment connection sizes, which are consistently used throughout the system and identified by symbols and colors.

OsseoSpeed® EV

Straight Conical

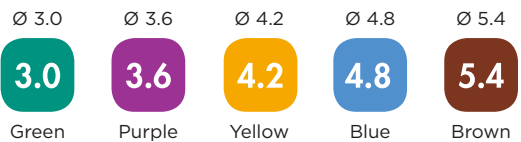
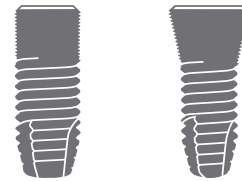

OsseoSpeed® Profile EV

For additional information on OsseoSpeed Profile EV, please refer to the OsseoSpeed Profile EV manual/ product catalog.

OsseoSpeed® Profile EV

Straight Conical

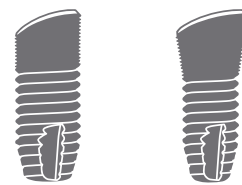

Implant size/tooth position

The design philosophy of the Astra Tech Implant System EV is based on the natural dentition utilizing a site-specific, crown-down approach supported by an intuitive surgical protocol and a simple prosthetic workflow.

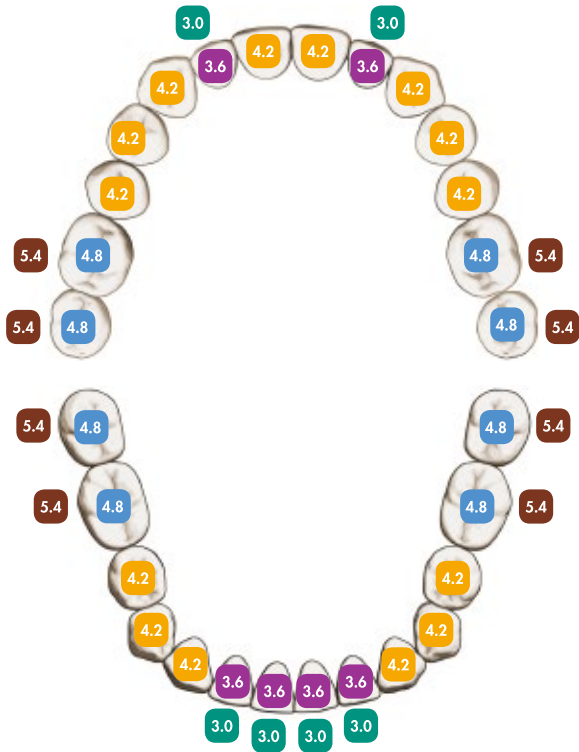

Multiple considerations are required for each tooth replacement; the support needed for the final restoration in the particular position, soft-tissue healing and implant design and size. The illustration indicates the recommended implant sizes in relation to the natural dentition, provided there is sufficient bone volume and space in relation to adjacent dentition.

Implant-abutment interface connection

The **OsseoSpeed EV** implant has a unique interface with a one-position-only placement for restorative procedures and components, e.g. the Atlantis patient-specific abutments. The interface also allows for the flexibility of six-position indexing of prefabricated abutments, while index-free abutments can be seated in any rotational position.



OsseoSpeed EV

Abutment placement option

One-position-only

Atlantis patient-specific, abutments will seat in one position only.



Six positions

Indexed abutments will seat in six available positions.



Index free

Index-free abutments will be seated in any rotational position.



Tray concept

The tray layout and components are organized to support the user throughout the entire surgical procedure. The tray design eliminates the need for rubber grommets for holding drills and instruments, which simplifies the cleaning process.

The layout is printed on the overlay, which is snapped onto the tray base. This solution offers the possibility of adapting the tray's contents according to individual preferences.



Tray logics

The color-coded, large tray has a drill marking system for ease of use and effective handling throughout the procedure, based on the following principles:

- Drills for the spongy bone preparation are color-coded white and marked with drill numbers 1-6 on the drill shaft.
- Drills for the mandatory cortical bone preparation are color-coded according to the implant and marked with either an A or B for straight implants or A/B for conical implants.
- Drills for removing the apical bone support, V-drills, and drills for widening of the entire osteotomy, X-drills, are color-coded according to the implant and marked with V or X.
- In addition to the diameter, all drill shafts are marked with a number or letter for easy identification and reference.

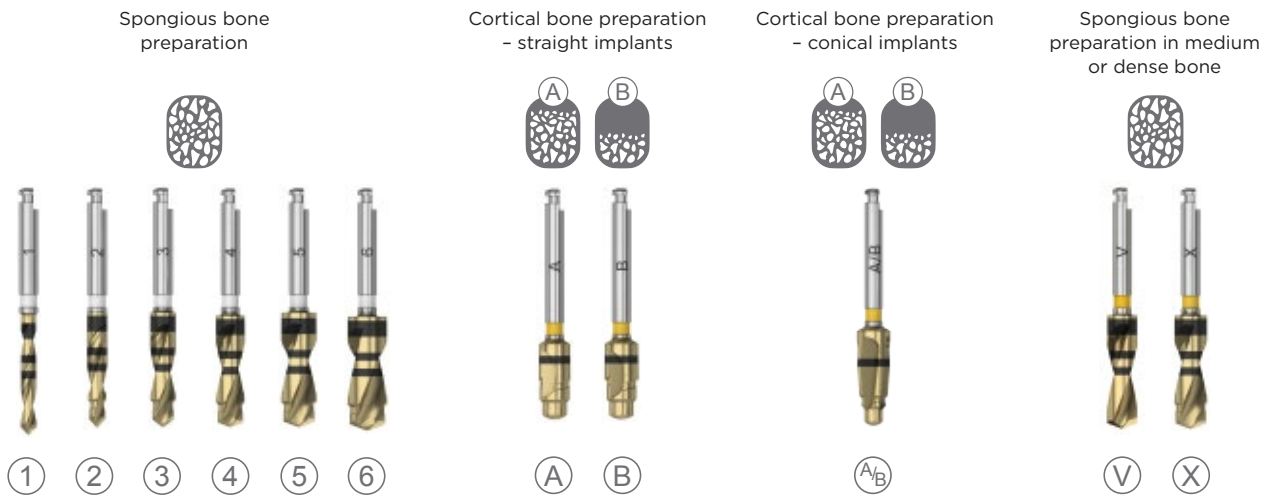



3.6 4.2 4.8
 P_{4.2} P_{4.8}

Overlay 1



Accommodates all implant lengths and designs for OsseSpeed EV straight and conical implants including OsseSpeed Profile EV for the most commonly used implant diameters.



3.0 3.6
 4.2 4.8 5.4
 P_{4.2} P_{4.8}

Overlay 2

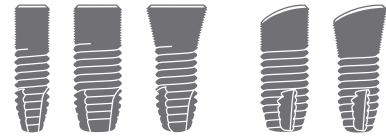

Accommodates the complete range of diameters for OsseSpeed EV straight and conical implants, including OsseSpeed Profile EV, lengths 8-17 mm.



3.0 3.6
 4.2 4.8 5.4
 P_{4.2} P_{4.8}

Overlay 3

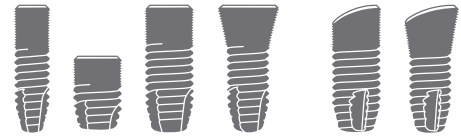

Supports the full implant assortment.



Washtray EV

Automated reprocessing of surgical instruments. The Washtray allows for machine cleaning, disinfection and subsequent steam sterilization of instruments.



Small Tray EV





A flexible, compact and convenient small tray for restorative and surgical procedures and a storage option.



Product identification

Throughout the Astra Tech Implant System EV, markings, color coding and geometrical symbols simplify the correct identification of corresponding components.

Each implant-abutment connection size is identified by a specific color, which is used consistently throughout the system. The color is applied directly to components, instruments and on the tray, as well as on packaging and information material, where appropriate.

The following components and/or packaging are color-coded:

| | | | | |
|---|---|---|---|---|
| Ø 3.0 | Ø 3.6 | Ø 4.2 | Ø 4.8 | Ø 5.4 |
|  |  |  |  |  |
| Green | Purple | Yellow | Blue | Brown |

| | |
|---|---|
|  |  |
| OsseoSpeed Profile EV | |



Healing components



Abutment screws for all two-piece abutments



Packaging for components on implant-level



Impression components on implant-level



Laboratory components on implant-level

Pre-operative procedures

Pre-operative examination

An evaluation of the patient's general and oral health, with clinical and radiographic examinations, must be performed. Particular attention should be given to mucous membranes, jaw morphology, dental and prosthetic history, and signs of oral dysfunction.

Radiographic analysis should be used to evaluate bone topography of the residual alveolar process. The initial radiographic evaluation, together with the clinical examination, is the basis for determining whether or not a patient is a candidate for implant treatment.

If the patient is found to be suitable, a more thorough clinical examination of the area for treatment and the opposing jaw should be performed. Any local pathology in the jaws should be treated before implant placement.

Pre-operative planning

Pre-operative planning should be based on the expected restorative treatment outcome. The Astra Tech Implant System EV assortment is designed to meet the prosthetic needs for the tooth replacement planned. The prosthetic versatility in materials, designs and sizes is aligned with the implant for support of the tooth replacements in the different positions in the jaw.

To achieve the expected outcome, treatment planning should include all stages of the procedure, from healing time and components to provisional and final restorations.

Today, digital processes with CBCT scans, together with optical surface scans, can replace or complement models mounted on an articulator and provide (analog or virtual) information of the relationship between jaws and teeth. A diagnostic wax-up with the missing teeth replaced provides important information in the planning phase. Based on analysis and evaluation of the occlusal table, force distribution and preferred sites for the implants, an optimal plan can be achieved.

The transparent Radiographic Implant Guides displaying implants in different magnifications are helpful in planning optimal position, direction and implant size. When working in a digital environment, the planning software provides a library of the different implants.



Simplant, the computer guided implant treatment software, can be used for the Astra Tech Implant System EV to ensure accurate planning for optimized implant position and placement.

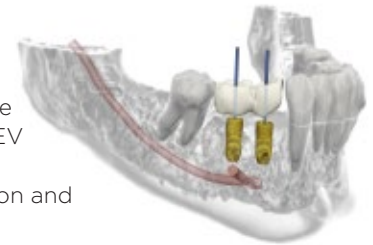

Even though the final treatment approach may be determined at the time of surgery, consider the following based on the quality of supporting bone and expected initial stability of the implant(s):

- One- or two-stage surgical procedure
- Immediate or early loading protocol
- Expected healing time before loading

When the prerequisites for immediate loading cannot be met, an early loading protocol (at least six weeks healing period) may be considered.

In all situations, bone quality and quantity, primary stability achieved, design of restoration, and loading conditions should be carefully examined and assessed by the clinician when determining time to loading of implants for each individual case.



Before treatment begins, the patient should be informed about the results of the pre-operative examination and given a clear explanation of what is entailed by the planned treatment, including the expected outcome, maintenance requirements and risks involved.

Clinical application

OsseoSpeed EV implants are indicated for immediate placement in extraction sites and/or in partially or completely healed alveolar ridges using a one- or two-stage surgical procedure.

Implants with the OsseoSpeed surface are especially indicated for use in soft bone situations where implants with other surface treatments may be less effective.

OsseoSpeed EV implants can be used in an immediate loading protocol. However, for single-tooth replacement in soft bone or when using a 6 mm implant, where primary implant stability may be difficult to maintain, immediate loading may not be appropriate and thus not recommended.

| Implant shape | General clinical application | 3.0 | 3.6 |
|---|---|--|---|
| Straight  | Suitable in the majority of situations. | For replacement of maxillary lateral and mandibular central and lateral incisors when there is not enough space for a wider implant. | Used in situations with limited bone volume or space between adjacent teeth, where a 4.2 mm implant is judged to be too wide. |
| Conical  | In situations with limited bone volume where a larger prosthetic platform is preferred. | N/A | N/A |

Precaution: When treatment planning for implant with 6 mm length consider the widest possible implant, a two-stage surgical approach and splinting of implants. Closely monitor the patient for peri-implant bone loss or change in the implants' response to percussion. If the implant shows greater than 50% bone loss or mobility, consider possible removal of implant.

Based on mechanical strength considerations, it is recommended to always place the widest implant possible for the edentulous space. This is particularly important in the posterior regions of the jaws where loading forces are high and considerable bending moments could be generated.

In all cases, it is important to consider loading conditions when determining the number and spacing of implants.

| 4.2 | 4.8 | 5.4 |
|--|--|--|
| Suitable in the majority of situations. | Used in situations with enough bone volume. | Suitable in situations with wide ridges and large edentulous spaces. |
| Suitable in situations with limited bone volume where a 3.6 mm implant diameter is the choice but where a larger prosthetic platform is preferred. | Suitable in situations with bone volume where a 4.2 mm implant diameter is the choice but where a larger prosthetic platform is preferred. | N/A |

Surgical components and instruments overview

Implant sites are prepared in a step-by-step procedure using different diameter drills, instruments and verification tools, ensuring an efficient and atraumatic preparation. All drilling in the bone should be performed at a maximum of 1500 rpm using profuse external irrigation with a saline solution. An intermittent drilling technique will help prevent heating of the bone and create a pumping effect for efficient removal of bone tissue.

Astra Tech Implant System EV drills:

- Excellent cutting properties
- Laser-etched depth indication lines
- Sterile packaging
- Multiple-use* with option for single-use
- In addition to the diameter, all drills shafts are marked with a number/letter for easy identification and reference
- Color-coded

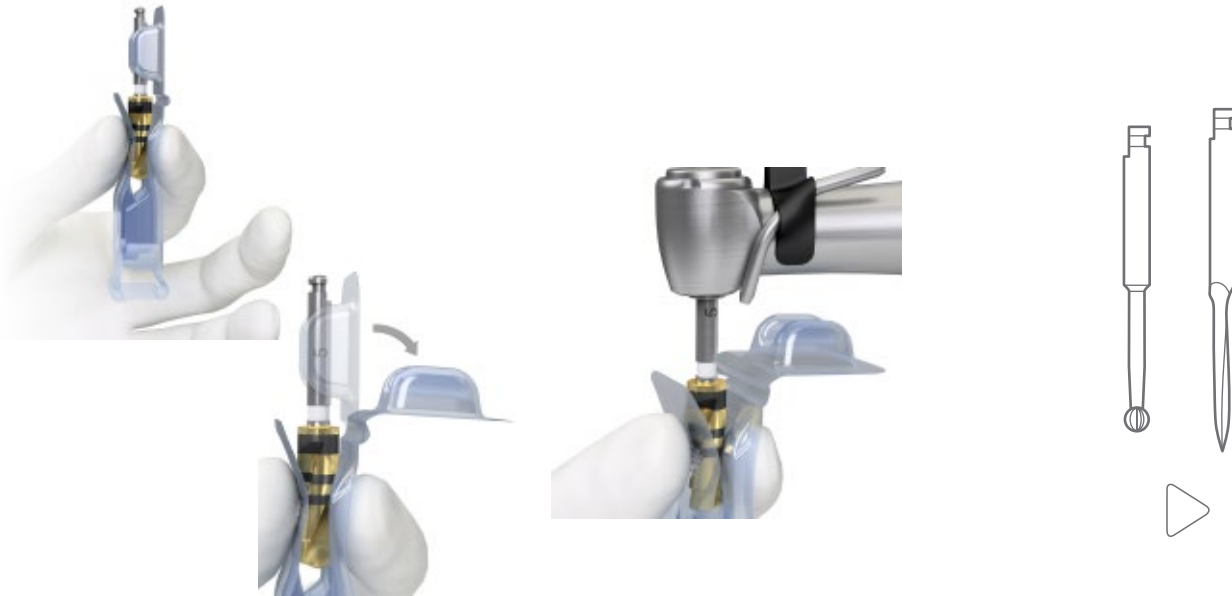

Packaging

- Open the package.
- Pour the blister onto a sterile area.
- Secure the drill by squeezing the blister.
- Expose the drill shaft by bending back the top of the blister.

Pick-up

- Engage the drill with the contra angle.

Guide Drill EV / Precision Drill EV

Used for marking and creating a starting point.

Note: The Precision Drill EV is an extremely sharp, single-use-only drill and should never be handled manually once out of its package.

* All drills except Precision Drill EV can be used for approximately ten cases. They should be carefully cleaned and sterilized after each surgery and replaced as soon as a decrease in their cutting efficiency is observed.



Drill packaging*



*Patent pending

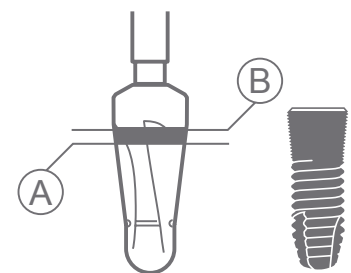
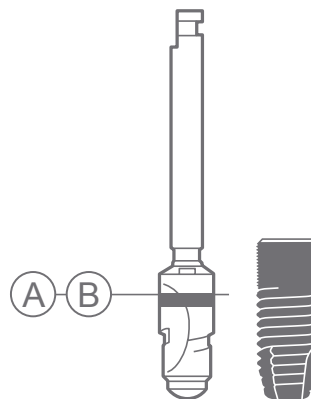
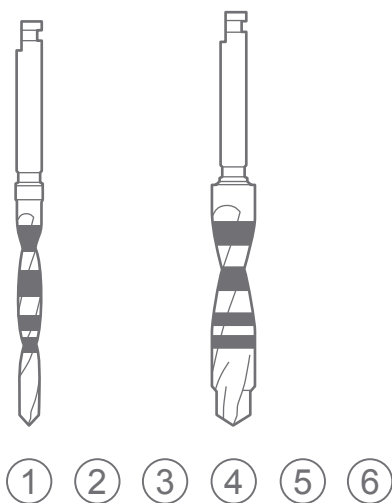

Spongy bone preparation

Twist Drill: Used for initial preparation and evaluation of the bone (1).

Step Drill: Used for site preparation, resulting in a stepped osteotomy with apical bone support for the implant. The drills (2)–(6) provide guidance during the drilling process.

- Color: white
- Markings: diameter and drill number
- Length: available in short (6–13 mm) and long (6–17 mm)

Cortical bone preparation – straight implants

Mandatory preparation of the cortical layer to reduce pressure in the bone around the implant neck.

Select (A)- or (B)- Cortical Drill EV according to cortical bone thickness.

- (A) - thin cortical bone < 2 mm
- (B) - thick cortical bone ≥ 2 mm

- Color: corresponds to implant
- Markings: diameter and drill letter
- Length: one option

Note: There are separate cortical drills specific for the 6 mm implant.



Cortical bone preparation – conical implants

Select the A- or B- depth indication according to the cortical bone thickness.

Apical border of the indication line indicates the minimum depth needed to fit the implant.

- (A) In thin cortical bone, drill to the depth indication line as shown in the illustration.
- (B) In thick cortical bone, drill to the full depth of the depth indication line as shown in the illustration.

Make sure enough depth is provided for the entire implant.

- Color: corresponds to implant
- Markings: diameter and drill letter
- Length: one option

Surgical components and instruments overview

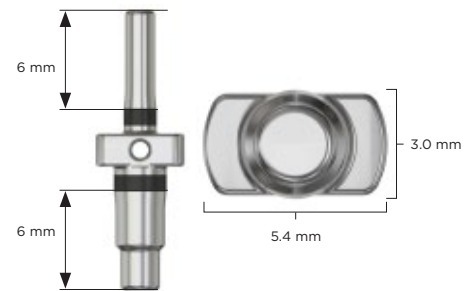
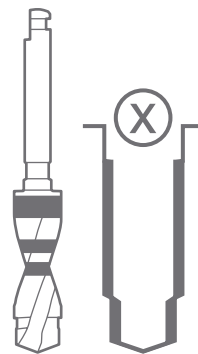
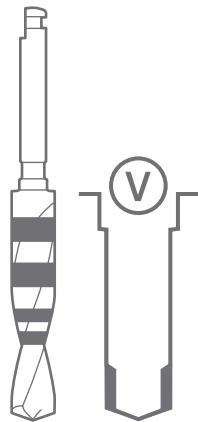

Spongy bone preparation - in medium or dense bone

V-Twist Drill - apical preparation

Following opening of the marginal cortical layer with cortical drill (A), (B) or conical drill (1/2), the (V)-twist drill is used to remove the apical step and creating a straight osteotomy.

The (V)-Twist Drill is strongly advocated in most situations to remove the apical bone contact and hereby reduce the risk for high installation torque and periapical bone pressure.

- Color: corresponds to implant **Note:** for conical implants, this color refers to the implant body diameter.
- Markings: diameter and (V)
- Length: available in short (6 -13 mm) and long (6 -17 mm).

X-Step Drill - body and apical preparation

Following opening of the marginal cortical layer with cortical drill (B) or conical drill (1/2) to level B, the (X)-step drill is used in dense bone situations to widen the entire osteotomy, i.e. the body portion of the osteotomy and remove the apical bone contact.

- Color: corresponds to implant **Note:** for conical implants, this color refers to the implant body diameter.
- Markings: diameter and (X)
- Length: available in short (6 -13 mm) and long (6 -17 mm).

Direction Indicator EV

Used for visualizing the position and direction of the prepared osteotomy.

The narrow end is used after drill (1) and the wider end is used after drill (3).

A laser marking indicates the 6 mm depth. The flange (collar) of the instrument indicates the smallest (3.0) and greatest (5.4) implant platform size.

Direction Indicator EV is equipped with a hole for attaching a safety thread.

Measuring osteotomy depth

Carefully measure the depth of the osteotomy. Use the same clinical reference point for the depth as for the planned implant position.

The depth should allow the implant to be level with or slightly submerged in relation to the adjacent marginal bone.

Drilling depth

The drilling depth is measured from the widest part of the drill tip up to the indication line. Two drill lengths are available – short (6–13 mm) and long (6–17 mm).

Additional tip depth is maximum 1.0 mm regardless of the drill diameter.



Implant Driver Extender EV-GS

Used for extending the length of a drill, Implant Driver EV or Implant Driver EV-GS. Ensure sufficient irrigation when using the extender.

Implant Depth Gauge EV

Used for measuring the depth of the implant site.

- Markings: corresponds to the implant lengths 6–17 mm

The other end of the gauge can be used as a measuring probe.

- Markings: 0–15 mm



Note: The depth gauge is designed with waist to facilitate the identification of the 13–15 mm marking.

Implant Driver EV

Used for picking up and installing the implant in the prepared osteotomy. The Implant Driver EV can engage into any of the six positions of the implant. The body of the driver has a hexagonal geometry with dimples.

Note: To facilitate optimal placement of pre-designed abutments, align one of the dimples buccally.

The reference point (“0”) of the depth markings is the intended bone level, i.e., the lowest point of the bevel.

- Color: corresponds to implant
- Markings: depth and diameter
- Length: two options

Implant packaging and handling

The packaging includes a 2D barcode for simplified inventory control.



Packaging

- Packages contain protective blisters that hold the components.

Labels

- Three peel-off labels are provided for the patient's treatment record and for communicating with the restorative team.

Implant container

- Open the blister package.
- Pour the sterile inner container onto a sterile area.
- Remove the cap from the container using a twisting motion to expose the top of the implant.

Note: Marked with implant size and length

Implant pick up

- Attach the appropriate Implant Driver EV to the contra angle with a hexagon chucking system or Surgical Driver Handle.

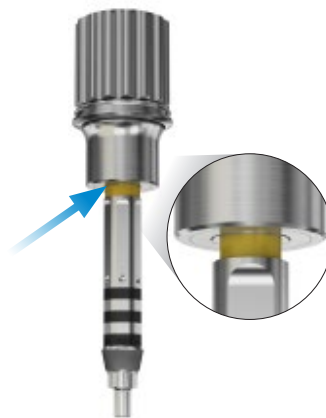
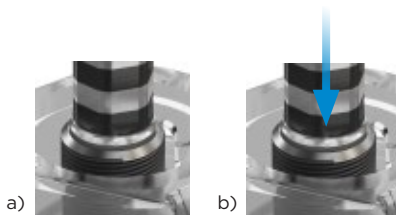

Implant pick up

- Make sure that the implant driver is fully seated into the implant (a).
- Press downwards to activate the carrying function before picking up the implant (b).
- When picking up the implant from the inner container, do not use excessive pressure.

Attach the Implant Driver EV

- Attach the Implant Driver EV by pressing it firmly into the Surgical Driver Handle EV. The driver is correctly seated when the color coded marking is just in contact with the handle.

Manual implant pick up

- Use the Implant Driver EV together with Surgical Driver Handle EV to pick up the implant.

Drilling protocol for OsseoSpeed® EV – straight

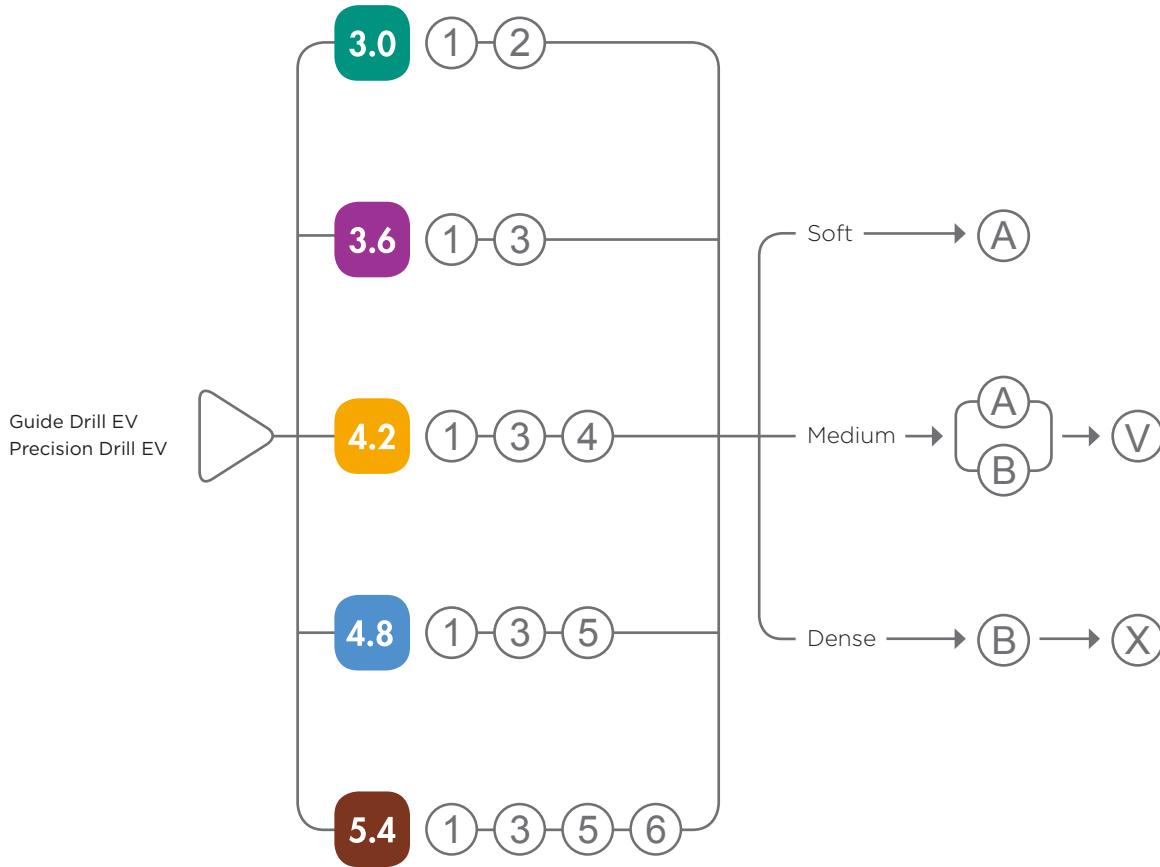

Soft bone

- E.g. posterior maxilla.
- The stepped osteotomy, providing apical bone contact, is maintained.

Medium bone

- Vast majority of cases.
- The apical portion of the osteotomy is widened using the (V)-drill.

Dense bone

- E.g. anterior mandible.
- The apical and body portions of the osteotomy are widened using the (X)-drill.

Select (A)- or (B)- Cortical Drill EV according to cortical bone thickness.



Thin cortical bone (less than 2 mm)



Thick cortical bone

For details go to page 30.



Drilling protocol for OsseoSpeed® EV – conical

Conical implants are available for situations with limited bone volume where a diameter 3.6 or 4.2 mm implant body is the choice, but where a larger prosthetic platform is preferred.

Note: If an additional spongy bone preparation with V or X drill is performed, use the color that refers to the implant body diameter.

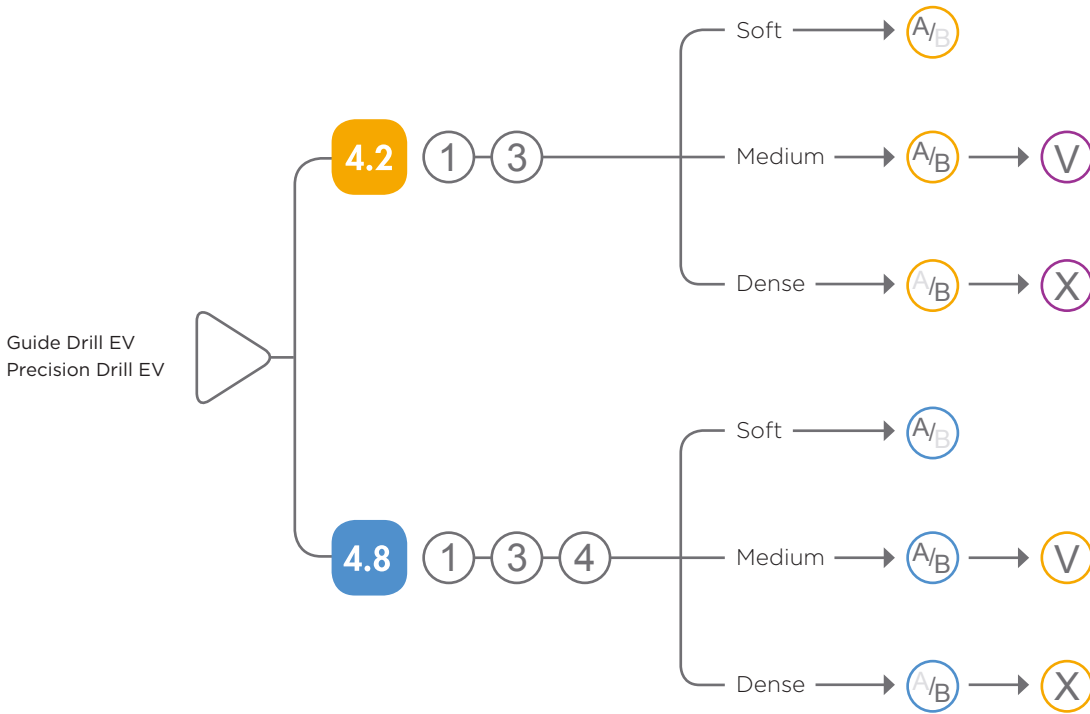

Note: for conical implants, color refers to the implant body diameter

Soft bone

- E.g. posterior maxilla.
- The stepped osteotomy, providing apical bone contact, is maintained.

Medium bone

- Vast majority of cases.
- The apical portion of the osteotomy is widened using the (V)-drill.

Dense bone

- E.g. anterior mandible.
- The apical and body portions of the osteotomy are widened using the (X)-drill.

Select the A- or B depth indication according to the cortical bone thickness.



Thin cortical bone (less than 2 mm)



Thick cortical bone

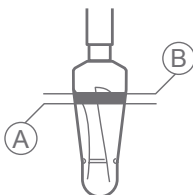

For details go to page 30.

Expanded drilling protocol for OsseoSpeed® EV – straight OsseoSpeed® EV – conical

In sites with compromised bone, the drilling protocol can be expanded to provide further guidance with more drilling steps. This approach is particularly useful in situations with an extremely narrow alveolar ridge (knife-edge).



Note: for conical implants, color refers to the implant body diameter

Step-by-step implant placement Medium bone quality

4.2



Below is a step-by-step protocol for the preparation and installation of an OsseoSpeed EV 4.2 S, 13 mm.

Note: All drilling should be performed at a maximum speed of 1500 rpm with profuse irrigation.



Twist Drill EV 1.9 ①

- Guide Drill EV or Precision Drill EV can be used to create a pilot hole prior to using the Twist Drill ①.
- Drill in the planned direction to the appropriate depth.
- The drilling will provide valuable information about the cortical and spongy bone.
- Insert the smaller end of the Direction Indicator EV into the site to visualize/verify the direction.

Note: The depth should allow the implant to be level with or slightly submerged in relation to the adjacent marginal bone.

Step Drill EV 2.5/3.1 ③

- Drill in the planned direction to the appropriate depth.
- Insert the larger end of the Direction Indicator EV into the site to visualize/verify the direction.

Step Drill EV 3.1/3.7 ④

- Drill the implant site to the appropriate depth.

Step-by-step implant placement Medium bone quality

4.2

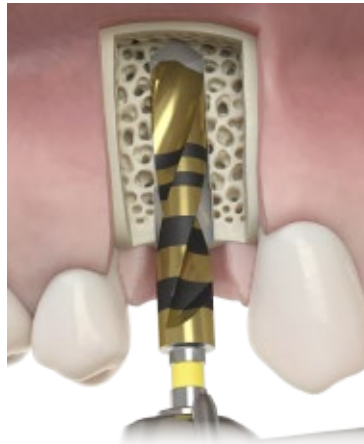

Cortical Drill EV

- Drill with the Cortical Drill EV to the full depth as indicated by the marked line. Use the cortical drill based on the cortical bone thickness:

Cortical Drill (A) 
for a thin cortical bone

Cortical Drill (B) 
for a thick cortical bone

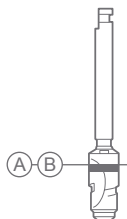

Spongy bone preparation - in medium bone

V-Twist Drill - apical preparation

Following opening of the marginal cortical layer with cortical drill (A) or (B), the (V)-twist drill is used to remove the apical step of the osteotomy.

The (V)-Twist Drill is strongly advocated in most situations to remove the apical bone contact and hereby reduce the risk for high installation torque and periapical bone pressure.

Measuring the osteotomy depth

- Carefully measure the implant site depth after drilling using the Implant Depth Gauge EV.
- Use the same clinical reference point for the depth as for the planned implant position.

Note: The depth should allow the implant to be level with or slightly submerged in relation to the adjacent marginal bone.

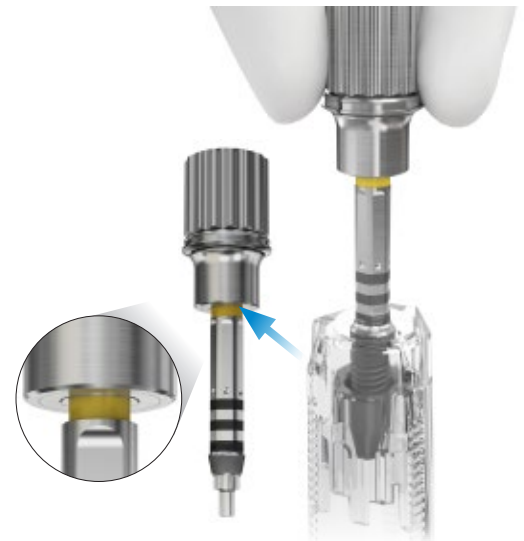

Implant pick up

- Attach the appropriate Implant Driver EV to the contra angle.
- Make sure that the implant driver is fully seated into the implant (a).
- Press downwards to activate carrying function before picking up the implant (b). Do not use excessive pressure.

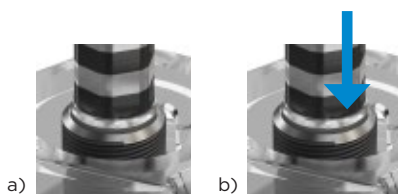

Machine implant installation

- Install the implant with the contra angle at low speed (25 rpm) under profuse irrigation and the maximum torque set to 45 Ncm.
- Allow the implant to work its way into the osteotomy. Avoid applying unnecessary pressure.

Note: Do not exceed 45 Ncm when installing the implant. If not completely seated before reaching 45 Ncm, reverse/remove the implant and widen the osteotomy appropriately (see Additional osteotomy preparation).

It is recommend to have a titanium forceps available in case the implant driver does not provide sufficient carrying function during the removal procedure.

Manual implant installation

- Attach the Implant Driver EV by pressing it firmly into the Surgical Driver Handle EV.
- The driver is correctly seated when the color coded marking is just in contact with the handle.
- Pick up and install the implant.

Step-by-step implant placement Medium bone quality

4.2

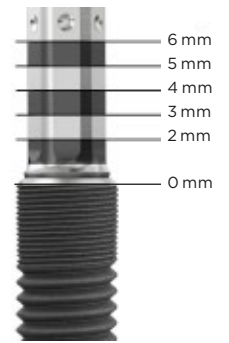

The reference point ("0") for the depth markings is the lowest point of the bevel.



Attach

- Attach the Implant Driver EV and Surgical Driver Handle into the wrench until there is an audible click.

Final positioning

- Position one of the dimples on the implant driver buccally to facilitate optimal placement of pre-designed abutments using the Torque Wrench EV together with Surgical Driver Handle.
- Release the implant driver by lifting it gently from the implant.

Finalizing implant installation

- Continue the procedure for finalizing the installation of the implant according to a one- or two-stage approach.

One-stage surgical protocol

HealDesign EV

- Round shapes are indicated for all positions in the mouth
- Triangular design for anterior implant sites to mimic the shape of incisors and canines
- Heights and diameters are designed to correspond with final abutments to provide soft tissue sculpturing

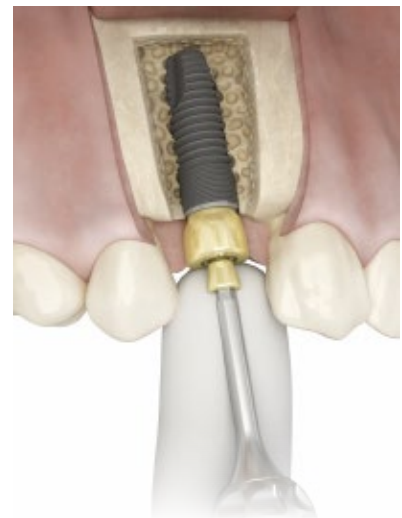

Installation

- Select a HealDesign EV to develop the desired soft tissue anatomy.
- Pick up and install the sterile HealDesign EV directly from the blister package, using the Hex Screwdriver EV.

HealDesign EV, round

- Manually secure the healing abutment using light finger force (5-10 Ncm).

HealDesign EV, tri

- When using the two-piece triangular HealDesign EV, first seat it with a Hex Screwdriver EV.
- Rotate the abutment sleeve until the desired index position is reached.
- Manually tighten the healing abutment screw using light finger force (5-10 Ncm).

Note: When removing a two-piece component, keep the sleeve and screw assembled.

Two-stage surgical protocol

Cover Screw EV

- One option for each interface connection



Cover Screw EV

- Insert the Cover Screw EV using the Hex Screwdriver EV.
- Tighten with light finger force (5-10 Ncm).
- Reposition the mucoperiosteal flaps carefully and suture tightly together.

Torque Wrench EV – surgical handling

A Torque Wrench EV together with the Surgical Driver Handle EV are used for manual implant installation and final positioning.

When used together with the Restorative Driver Handle, the torque wrench is also used for tightening abutment screws and bridge screws.



Assemble

- Assemble the head of the wrench and the body by pushing the components together and turning until there is an audible click.

Attach

- Attach the Implant Driver EV by pressing it firmly into the Surgical Driver Handle EV.
- The driver is correctly seated when the color coded marking is just in contact with the handle.
- Pick up and install the implant.
- Insert the driver handle and implant driver into the wrench until there is an audible click.

Handling

- Use a finger on the top of the driver handle to keep it steady and in place. Then gently pull the arm of the torque wrench in the direction of the arrow until the desired torque is achieved.

Note: The arm of the torque wrench must not go beyond the end of the scale, as this could result in damage and inaccurate torque readings.

Note: The arrow on the head of the wrench shows the direction in which the wrench is functioning.



Cleaning and sterilization instructions

Products within Astra Tech Implant System EV are designed to be cleaned and sterilized before clinical use with the exception of sterile products. Please follow the instructions stated in the Cleaning and sterilization instructions for Astra Tech Implant System EV.

The cleaning and sterilization instructions for Astra Tech Implant System EV assortment has been developed and validated by Dentsply Sirona. The instructions have been developed in accordance with the applicable standards.





Astra Tech Implant System®
Cleaning and sterilization instructions
for Astra Tech Implant System® EV



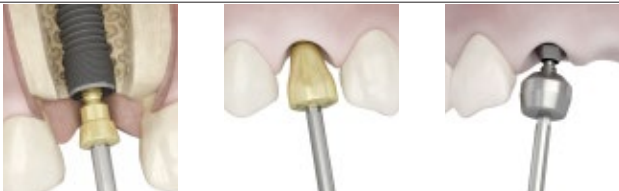
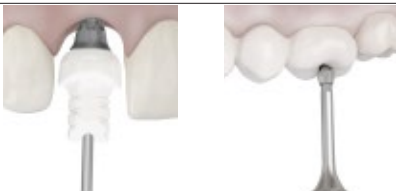
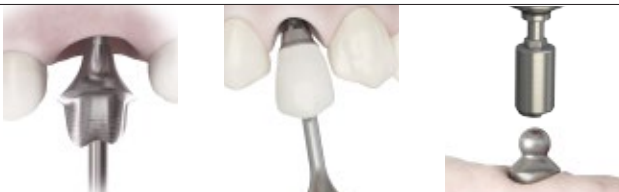

The image shows a collection of dental implant components. On the left is a white plastic tray with a blue lid, containing several small white cylindrical parts. To the right are three gold-colored abutments of different heights, a gold-colored ball abutment, a small black screw, and a long, thin metal ruler with a small screw and a key-like component attached to its end. In the top left corner of the image area is a circular logo that reads "NOW PART OF ASTRA TECH IMPLANT SYSTEM DENTSPLY SIRONA".

Cleaning and sterilization instructions for Astra Tech Implant System EV - 32671332

Torque guide – Recommended installation and tightening torque

| Type of product installation | | Torque – Ncm |
|---|--|--|
| <ul style="list-style-type: none"> Implant installations |  | <p>Maximum 45 Ncm</p> |
| <ul style="list-style-type: none"> Cover screws Healing components |  | <p>5-10 Ncm Manual/ light finger force</p> |
| <ul style="list-style-type: none"> Temporary abutments Temporary restorations on all levels |  | <p>15 Ncm</p> |
| <ul style="list-style-type: none"> Final abutments Single tooth restorations on implant level |  | <p>25 Ncm</p> |
| <ul style="list-style-type: none"> Final restorations on abutment level |  | <p>15 Ncm</p> |

Explanation of the symbols on labels and instructions for use

| | | | | | |
|--|---|---|---|---|---|
|  Date of manufacture | Date of manufacture. |  Single use | Do not re-use, Single use only. |  Consult instructions for use ifu.dentsplysirona.com | Consult instructions for use.* |
|  | Legal manufacturer. |  Do not re-sterilize | Do not re-sterilize. |  | LOT/BATCH number. |
|  Use by | Expired date. |  | GOST is the valid quality certification system in Russian Federation. |  | Article number. |
|  | Sterilized using irradiation. |  | Astra Tech Implant System® products carry the CE mark and fulfill the requirements of the Medical Device Directive. |  | Contains article number (GTIN number), lot number and quantity. |
|  | Caution: Federal (USA) law restricts this product to sale by or on a order of a dentist. |  Do not use if package is damaged | Do not use if package is damaged. | * To read PDF files you will need Adobe Reader. Download free of charge at get.adobe.com/reader . | |

Detailed overview on the drilling protocol for OsseoSpeed® EV



OsseoSpeed® EV Straight

| Implant/ abutment interface Ø | Implant Ø | Soft bone quality | Medium bone quality | Dense bone quality |
|-------------------------------------|--------------|---|---|--|
| 3.0 | 3.0 | ①-Twist Drill EV Ø1.9 ②-Step Drill EV Ø1.9/2.5 Ⓐ-Cortical Drill EV Ø2.5/2.7 | ①-Twist Drill EV Ø1.9 ②-Step Drill EV Ø1.9/2.5 Ⓐ-Cortical Drill EV Ø2.5/2.7 or Ⓑ-Ø2.5/3.0* Ⓥ-Twist Drill EV Ø2.5 | ①-Twist Drill EV Ø1.9 ②-Step Drill EV Ø1.9/2.5 Ⓑ-Cortical Drill EV Ø2.5/3.0 ⓧ-Step Drill EV Ø2.5/2.85 |
| 3.6 | 3.6 | ①-Twist Drill EV Ø1.9 ③-Step Drill EV Ø2.5/3.1 Ⓐ-Cortical Drill EV Ø3.1/3.3 | ①-Twist Drill EV Ø1.9 ③-Step Drill EV Ø2.5/3.1 Ⓐ-Cortical Drill EV Ø3.1/3.3 or Ⓑ-Ø3.1/3.6* Ⓥ-Twist Drill EV Ø3.1 | ①-Twist Drill EV Ø1.9 ③-Step Drill EV Ø2.5/3.1 Ⓑ-Cortical Drill EV Ø3.1/3.6 ⓧ-Step Drill EV Ø3.1/3.45 |
| 4.2 | 4.2 | ①-Twist Drill EV Ø1.9 ③-Step Drill EV Ø2.5/3.1 ④-Step Drill EV Ø3.1/3.7 Ⓐ-Cortical Drill EV Ø3.7/3.9 | ①-Twist Drill EV Ø1.9 ③-Step Drill EV Ø2.5/3.1 ④-Step Drill EV Ø3.1/3.7 Ⓐ-Cortical Drill EV Ø3.7/3.9 or Ⓑ-Ø3.7/4.2* Ⓥ-Twist Drill EV Ø3.7 | ①-Twist Drill EV Ø1.9 ③-Step Drill EV Ø2.5/3.1 ④-Step Drill EV Ø3.1/3.7 Ⓑ-Cortical Drill EV Ø3.7/4.2 ⓧ-Step Drill EV Ø3.7/4.05 |
| 4.8 | 4.8 | ①-Twist Drill EV Ø1.9 ③-Step Drill EV Ø2.5/3.1 ⑤-Step Drill EV Ø3.7/4.3 Ⓐ-Cortical Drill EV Ø4.3/4.5 | ①-Twist Drill EV Ø1.9 ③-Step Drill EV Ø2.5/3.1 ⑤-Step Drill EV Ø3.7/4.3 Ⓐ-Cortical Drill EV Ø4.3/4.5 or Ⓑ-Ø4.3/4.8* Ⓥ-Twist Drill EV Ø4.3 | ①-Twist Drill EV Ø1.9 ③-Step Drill EV Ø2.5/3.1 ⑤-Step Drill EV Ø3.7/4.3 Ⓑ-Cortical Drill EV Ø4.3/4.8 ⓧ-Step Drill EV Ø4.3/4.65 |
| 5.4 | 5.4 | ①-Twist Drill EV Ø1.9 ③-Step Drill EV Ø2.5/3.1 ⑤-Step Drill EV Ø3.7/4.3 ⑥-Step Drill EV Ø4.3/4.9 Ⓐ-Cortical Drill EV Ø4.9/5.1 | ①-Twist Drill EV Ø1.9 ③-Step Drill EV Ø2.5/3.1 ⑤-Step Drill EV Ø3.7/4.3 ⑥-Step Drill EV Ø4.3/4.9 Ⓐ-Cortical Drill EV Ø4.9/5.1 or Ⓑ-Ø4.9/5.4* Ⓥ-Twist Drill EV Ø4.9 | ①-Twist Drill EV Ø1.9 ③-Step Drill EV Ø2.5/3.1 ⑤-Step Drill EV Ø3.7/4.3 ⑥-Step Drill EV Ø4.3/4.9 Ⓑ-Cortical Drill EV Ø4.9/5.4 ⓧ-Step Drill EV Ø4.9/5.25 |



OsseoSpeed® EV Conical

| | | | | |
|-----|-----|--|---|---|
| 4.2 | 3.6 | ①-Twist Drill EV Ø1.9 ③-Step Drill EV Ø2.5/3.1 Ⓐ/Ⓑ-Conical Drill EV Ø3.1/4.2 | ①-Twist Drill EV Ø1.9 ③-Step Drill EV Ø2.5/3.1 Ⓐ/Ⓑ-Conical Drill EV Ø3.1/4.2** Ⓥ-Twist Drill EV Ø3.1 | ①-Twist Drill EV Ø1.9 ③-Step Drill EV Ø2.5/3.1 Ⓐ/Ⓑ-Conical Drill EV Ø3.1/4.2 ⓧ-Step Drill EV Ø3.1/3.45 |
| 4.8 | 4.2 | ①-Twist Drill EV Ø1.9 ③-Step Drill EV Ø2.5/3.1 ④-Step Drill EV Ø3.1/3.7 Ⓐ/Ⓑ-Conical Drill EV Ø3.7/4.8 | ①-Twist Drill EV Ø1.9 ③-Step Drill EV Ø2.5/3.1 ④-Step Drill EV Ø3.1/3.7 Ⓐ/Ⓑ-Conical Drill EV Ø3.7/4.8** Ⓥ-Twist Drill EV Ø3.7 | ①-Twist Drill EV Ø1.9 ③-Step Drill EV Ø2.5/3.1 ④-Step Drill EV Ø3.1/3.7 Ⓐ/Ⓑ-Conical Drill EV Ø3.7/4.8 ⓧ-Step Drill EV Ø3.7/4.05 |

*Select A- or B- Cortical Drill EV according to cortical bone thickness

**Select A- or B- depth indication according to cortical bone thickness

About Dentsply Sirona Implants

Dentsply Sirona Implants offers comprehensive solutions for all phases of implant therapy, including Ankylos®, Astra Tech Implant System® and Xive® implant lines, digital technologies, such as Atlantis® patient-specific solutions and Simplant® guided surgery, Symbios® regenerative solutions, and professional and business development programs, such as STEPPS™. Dentsply Sirona Implants creates value for dental professionals and allows for predictable and lasting implant treatment outcomes, resulting in enhanced quality of life for patients.

About Dentsply Sirona

Dentsply Sirona is the world's largest manufacturer of professional dental products and technologies, with a 130-year history of innovation and service to the dental industry and patients worldwide. Dentsply Sirona develops, manufactures, and markets a comprehensive solutions offering including dental and oral health products as well as other consumable medical devices under a strong portfolio of world class brands. As The Dental Solutions Company™, Dentsply Sirona's products provide innovative, high-quality and effective solutions to advance patient care and deliver better, safer and faster dentistry. Dentsply Sirona's global headquarters is located in York, Pennsylvania, and the international headquarters is based in Salzburg, Austria. The company's shares are listed in the United States on NASDAQ under the symbol XRAY.

Visit www.dentsplysirona.com for more information about Dentsply Sirona and its products.